

CENTRA

A rugged, sturdy, and modern steel frame with laminate tops or recycled HDPE for indoor and long-lasting outdoor use.

Available as tables, benches, or picnic tables with attached seating.



FEATURES

- All tables are 30" wide, available in 72" or 96" lengths. See material descriptions for indoor and outdoor models.
- Freestanding tables available in 30" and 42" heights.
- Benches are 17" high, 15" width. Multiple bench lengths – 30", 42", 72", or 96" – accommodate individual seats, wheelchair and other seating options.
- Wheelchair access for 30"H tables only.
- Picnic style tables with attached benches are available in 72" and 96" lengths.
 - Frames engineered to withstand weight without sagging at any length. Crossbars and angled framework ensure stability.
 - Designed to coordinate with other modern seating options, including some of Palmer Hamilton's chairs and stools.
- Glides and casters on indoor furnishings make sturdy furniture also easy to move for cleaning and reorganization of space.
- Glides and anchors for outdoor use, offering the option of permanent seating arrangement.

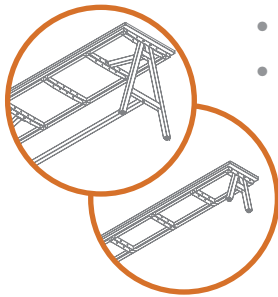

SIZE OPTIONS

- 6' and 8' tables lengths with or without attached benches (picnic style tables).
- 30" table width.
- 30" and 42" table heights.
- 30", 42", 72", and 96" bench lengths.

CONFIGURATIONS

- Connected or stand alone benches
- Small length benches allow for flexible seating options, including space for wheelchairs, perfect for including ADA compliant locations.
- Tables of both heights are perfect for using with chairs or stools. Clean design coordinates with our Jackson, Encore, or other lines.

FRAMES

- Our tables have self-supporting, MIG welded, unitized frame design.
- Boards are mounted to a 14 gauge formed steel apron. Top is then bolted to an A-frame style leg constructed of 16 gauge, 2" square tubing.

Indoor and outdoor seating in multiple configurations with a modern, industrial style.



- All metal parts are thoroughly cleaned to resist corrosion and provide maximum paint adhesion, finished with high-grade electrostatically applied baked-on epoxy powdercoat for superior resistance to abrasion, marring and scratching. The metal finish is a baked-on, lightly textured polyester powder coating.
- Durable powder coat finish, in our standard three options, and ten custom frame colors. See our website for non-standard colors. Minimum orders apply. Upcharge may apply.

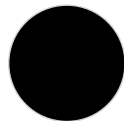

Black Textured
(BLK)



Chameleon Textured
(CHA)



Metallic Silver
(MS)

TOPS AND BENCHES

Indoor Tops and Benches

CENTRA offers a full choice of our standard laminate options for indoor applications.

- Standard weight top construction – 1-1/8" M3 industrial grade particle board. Constructed with HPL (decorative laminate) on the top side and a balanced backer on the bottom.
- **Group 1:** Choose your colors from Wilsonart® laminates. See their website. Palmer Hamilton standards are most colors

ending with '-38' or '-60'. Exceptions apply, including colors that begin with a 'Y' or end with a 'K-38' or 'K-60'.

- **Group 2:** Non-standard Wilsonart® premium laminates and standard Pionite®, Nevamar®, Arborite®, and Formica®.
- **Group 3:** Non-standard Wilsonart®, including premium 'Y' laminates, and premium Arborite®, Pionite®, Nevamar®, and Formica®
- **All premium laminates** are subject to an upcharge. Please contact Palmer Hamilton with questions regarding laminate selection.
- **Mix colors:** table tops and benches can be of different colors on picnic model units as well as individually ordered tables and benches.



- **Custom logo laminates** are available on table tops only at an upcharge.
- **Butcher Block wood** is also available for tops and benches. Material is 1 1/8" thick face-glued, finger joint rails finished with a clear catalyzed lacquer. Wood consists of standard mixed hardwoods which are a variation of different species containing similar color and grain patterns. Edge profile is 1/8" eased edge.

Use one or multiple benches to vary seating options, including wheelchair access..



Laminate Edge Options

- Our standard edge is EdgeGuard™, a sprayed-on polyurea eased edge treatment that provides superior resistance to moisture, eliminates unsanitary food traps, and is extremely tamper resistant. Edges stay sealed, preventing peeling and chipping. Durable for many years of use.
- Optional edge is a 3mm flat PVC edge, adhered to the particle board for a tight bond, available in fashion colors.
- See our website page "Edges" for colors.

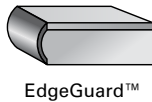

EdgeGuard™



PVC

Indoor/Outdoor Tops and Benches

- Palmer Hamilton has selected a tough performance High Density Polyethylene (HDPE) recycled lumber for our CENTRA line.
- 1-1/2" thick material is available in standard width planks, or 3/4" thick for variable width table top boards with coordinating bench design.
- Material includes UV inhibitors to prevent fading assuring long lasting color.
- The matte finish makes surfaces easily cleanable and resilient against vandalism.
- 100% recyclable.
- Outdoor material available in 12 neutral and 10 bright colors. Minimums may apply.
- Recycled poly picnic tables and benches must be of one color only.

HDPE poly colors

Standard colors

Available for standard delivery; no minimums.

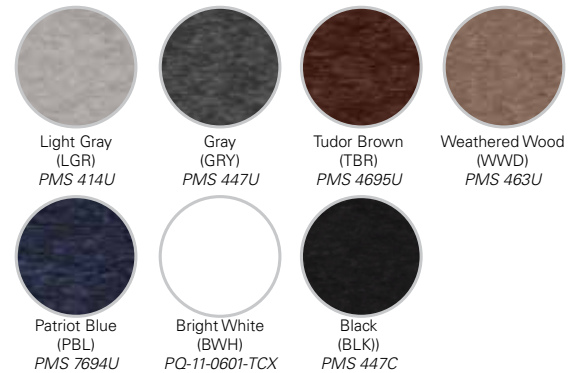

Custom colors

No minimums, but longer lead times may apply.

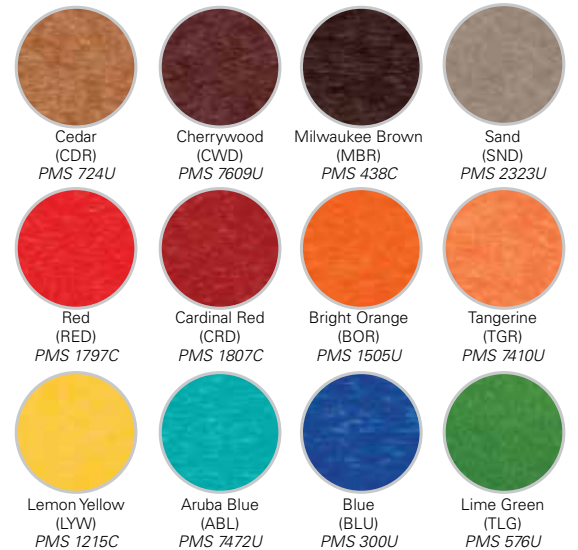

Limited colors

Infrequent production; call for availability.





Options for anchors or glides, or casters for tables extend configurations indoors or out.

Indoor/Outdoor Tops and Benches

- HDPE boards have bullnosed edges and small spaces between boards.

Picnic table style

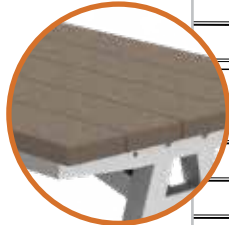
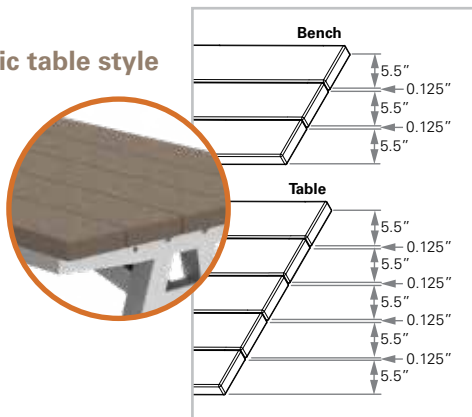

- Only anchor plates are provided. Anchor bolts to be provided by customer.
- Casters not available on benches.
- Benches can be anchored into position.

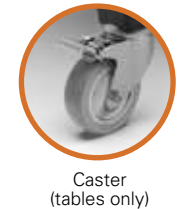
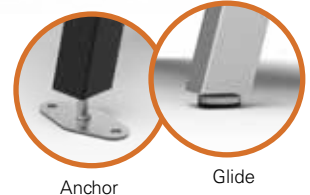

UMBRELLA HOLES

All 30" high tables in HDPE material have a centered umbrella hole.

WEIGHT CAPACITY

See chart on page 6 for number of seats per bench, based on approximately 250 lb per person.

CERTIFICATIONS

- HDPE Dimensional Lumber is 71% recycled content, and meets standards for a 9% Closed Loop Material, qualifying it for Green Circle Certification®.

SHIPPING

All models ship KD. Legs, glides, casters or anchors need to be attached.

WARRANTY

See our website for warranty details.

Multi-sized boards

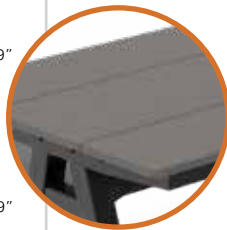
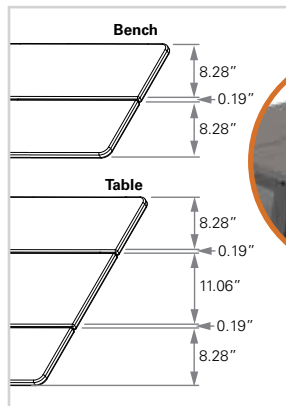

FOOT OPTIONS

- Freestanding units with glides standard on all models. Heavy duty locking caster option for indoor table use, or anchor option for secured applications.

Versatile industrial design that coordinates with other seating options.



DIMENSIONAL DRAWINGS

Benches

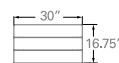
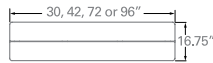
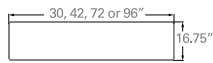

BENCH WITH GLIDES

HDPE BENCH WITH GLIDES

HDPE BENCH WITH ANCHORS

Indoor Tables

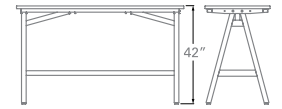
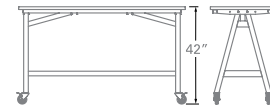
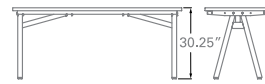
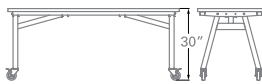
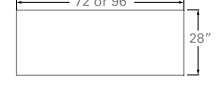
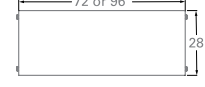
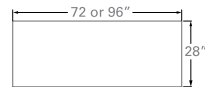
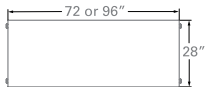

TABLE WITH CASTERS

TABLE WITH GLIDES

TALL TABLE WITH CASTERS

TALL TABLE WITH GLIDES

Outdoor Tables

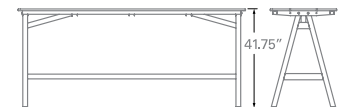
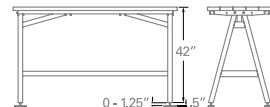
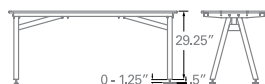
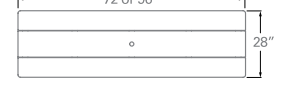
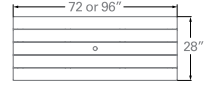
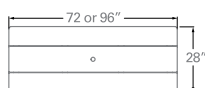
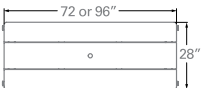

TABLE WITH CASTERS

TABLE WITH ANCHORS

TALL TABLE WITH ANCHORS

TALL TABLE WITH GLIDES

Picnic Tables

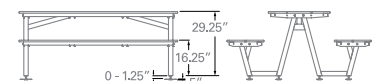
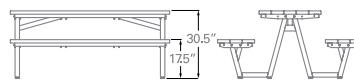
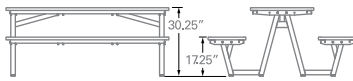
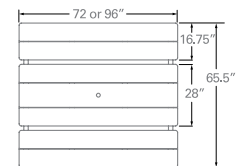
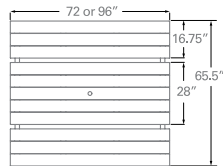
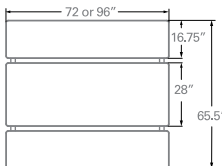

LAMINATE PICNIC TABLE WITH GLIDES

HDPE PICNIC TABLE WITH GLIDES

HDPE PICNIC TABLE WITH ANCHORS



SPECIFICATIONS

MODEL NUMBER	DESCRIPTION	TABLE DIMENSIONS H x W x L (in)	FOOTPRINT (in)	SEATING CAPACITY Adult/Child	PRODUCT WEIGHT (lbs)*				SHIPPING DIMS + W x D x H (in)	SHIPPING WEIGHT (lb) +			
					LM	BB	MB	RP		LM	BB	MB	RP
CEN24303072A	Picnic Table, attached Benches	30 x 28 x 72	65.5 x 72	6 / 8	253	250	229	297	17 x 30 x 72	320	317	296	364
CEN24303096A	Picnic Table, attached Benches	30 x 28 x 96	65.5 x 96	8 / 10	320	316	287	378	17 x 30 x 96	409	405	376	467
CEN24303072T	Table	30 x 28 x 72	28 x 72		122	120	111	141	14 x 30 x 72	194	192	183	213
CEN24303096T	Table	30 x 28 x 96	28 x 96		150	148	135	176	14 x 30 x 96	244	242	229	270
CEN24423072T	Table	42 x 28 x 72	28 x 72		142	141	131	161	14 x 30 x 72	214	213	203	233
CEN24423096T	Table	42 x 28 x 96	28 x 96		174	172	159	200	14 x 30 x 96	268	266	253	294

MODEL NUMBER	DESCRIPTION	BENCH DIMENSIONS H x W x L (in)	FOOTPRINT (in)	SEATING CAPACITY per bench Adult/Child	PRODUCT WEIGHT (lbs)*				SHIPPING DIMS W x D x H (in)	SHIPPING WEIGHT (lb) +			
					LM	BB	MB	RP		LM	BB	MB	RP
CEN24171730B	30" Bench	17 x 16.75 x 30	16.75 x 30	1 / 1	38	36	36	43	14 x 30 x 72	110	108	108	115
CEN24171742B	42" Bench	17 x 16.75 x 42	16.75 x 42	1 / 2	48	48	44	55	14 x 30 x 72	120	120	116	127
CEN24171772B	72" Bench	17 x 16.75 x 72	16.75 x 72	3 / 4	71	71	65	83	14 x 30 x 72	143	143	137	155
CEN24171796B	96" Bench	17 x 16.75 x 96	16.75 x 96	4 / 6	90	89	82	196	14 x 30 x 96	184	183	176	200

* Product weights listed are approximate.

+ Shipping Dimensions and Weights are based on one item and are for rough estimation only. Typically tables are shipped in bulk and packaged in the most efficient method.

LM = Laminate

BB = Butcher Block

MB = Multi-sized Boards

RP = Recycled Poly