

SPEC SHEET OF-B8WB
8' STANDARD EXPANDED METAL BENCH WITH BACK

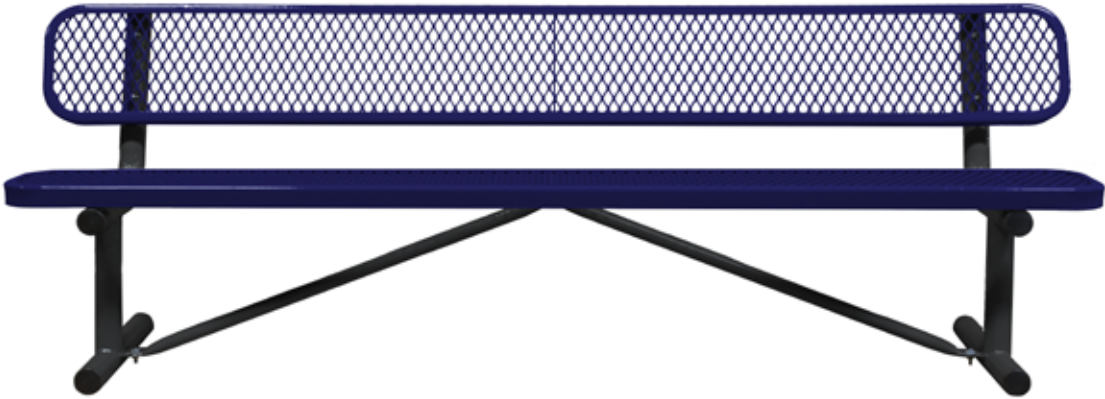

top view

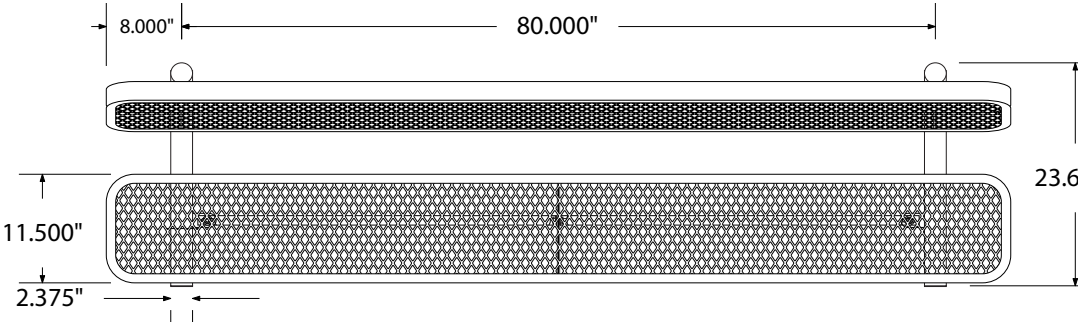

front view

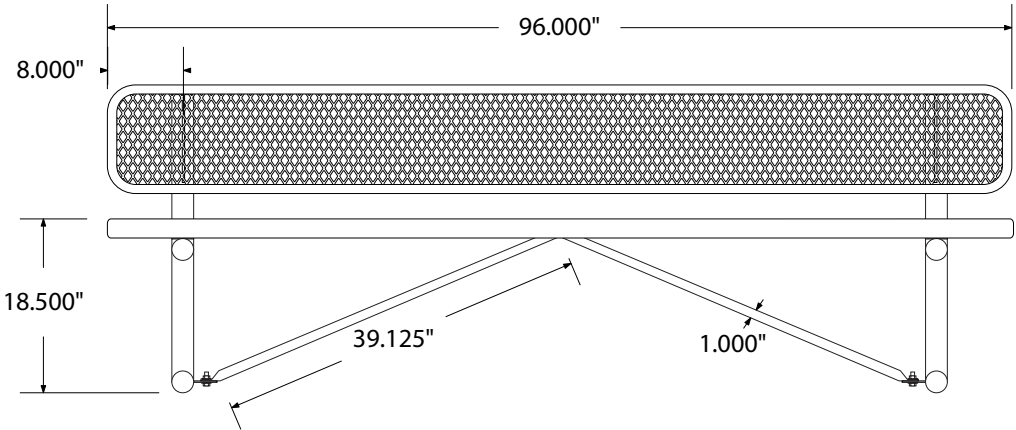

side view

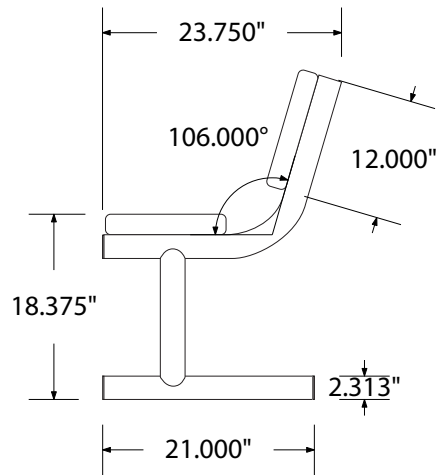

product finish



Coated Surfaces

- Thermoplastic coated Copolymer-based, environmentally safe
- Does not fade, crack, peel, or warp
- Applied at a thickness 25-30 mils
- 5 year warranty on coating



Construction

- Seat and back - 11 gauge steel
- Tubular understructure of galvanized steel finished in black polyester powder coating
- Galvanized hardware

Weight

- 180 lbs

mounting styles

P = Portable: no mount

SM = Surface Mount:
concrete anchors through
holes in feet

IG = In-Ground: J-rods set
in concrete through holes in
feet

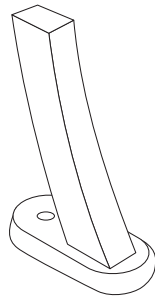

portable

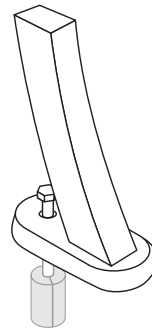

surface mount

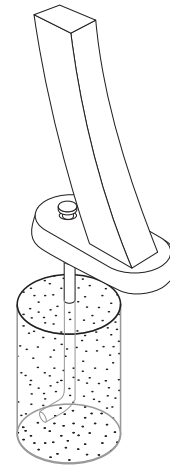

in-ground

All design specifics subject to change. For all products Palmer Hamilton reserves the right to make adjustments due to changing market conditions, product discontinuation, legislative requirements or other circumstances.

Visit our website to see the complete family of Palmer Hamilton products
800-788-1028 | www.palmerhamilton.com

70950

OF-B8WB Spec 0724

