

SPEC SHEET OF-RFNB6-PERF
6' PERFORATED BENCH WITHOUT BACK

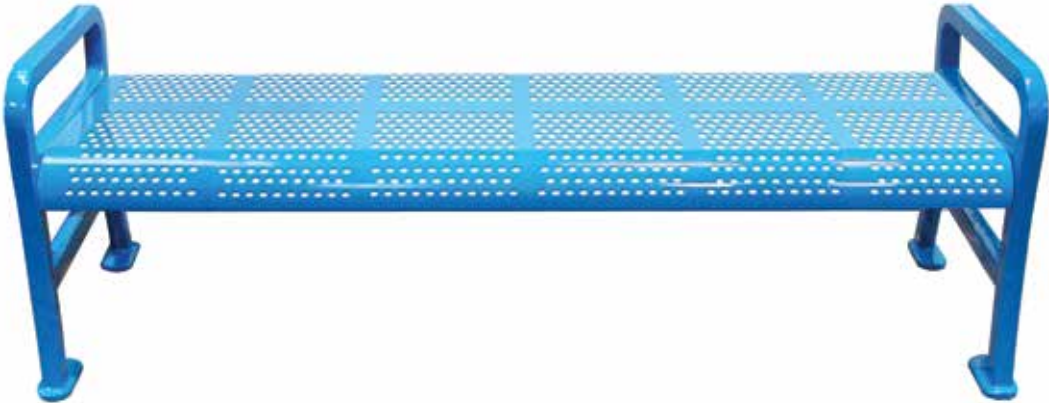

top view

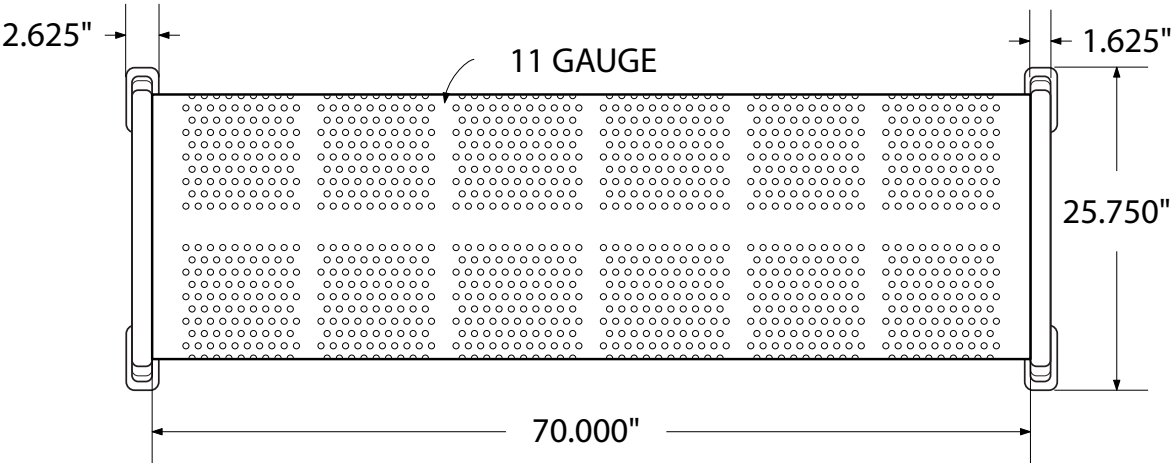

front view

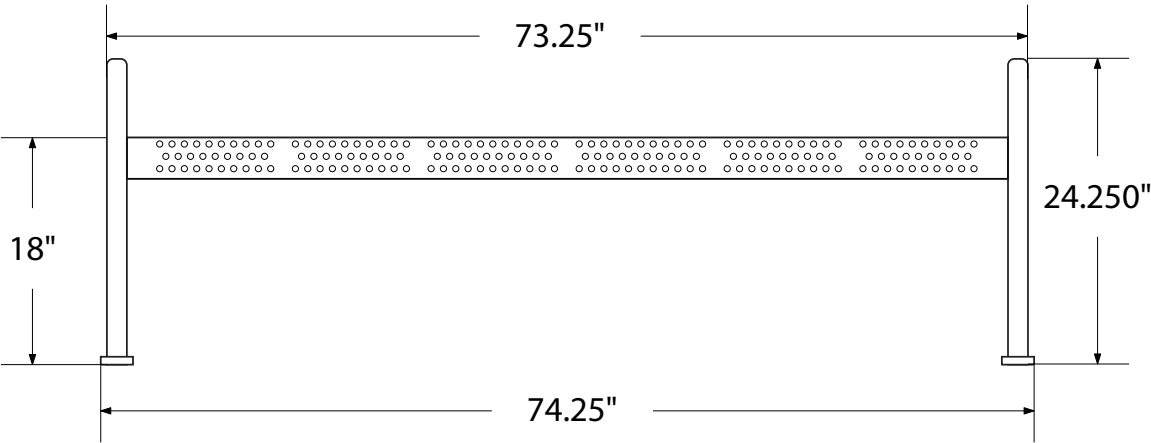

side view

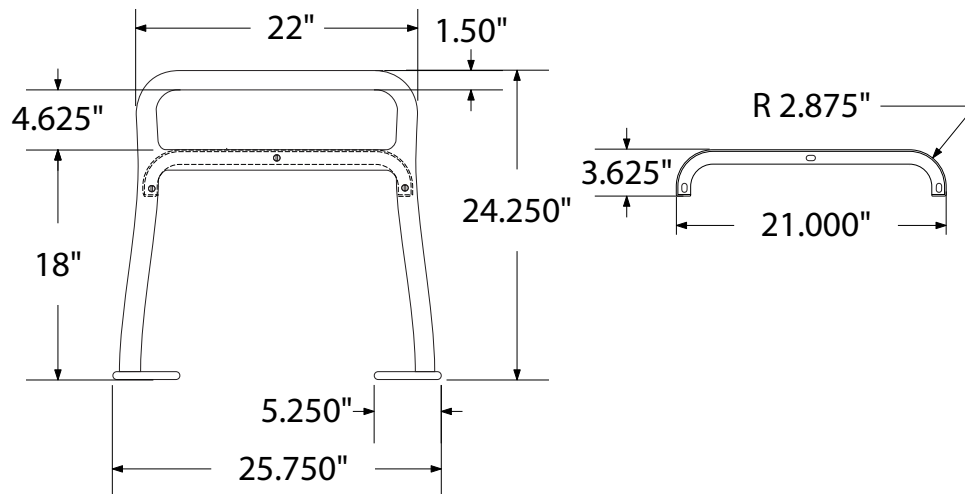

product finish



Coated Surfaces

- Thermoplastic coated
- Copolymer-based, environmentally safe
- Does not fade, crack, peel, or warp
- Applied at a thickness 25-30 mils
- 5 year warranty on coating

Construction

- Seat and back - 9 gauge steel
- Cast iron leg structures
- Galvanized hardware

Weight

- 175 lbs

mounting styles

P = Portable: no mount

SM = Surface Mount:
concrete anchors through
holes in feet

IG = In-Ground: J-rods set
in concrete through holes in
feet

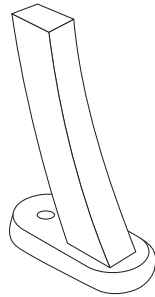

portable

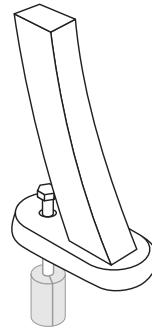

surface mount

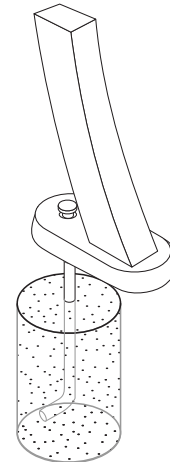

in-ground

All design specifics subject to change. For all products Palmer Hamilton reserves the right to make adjustments due to changing market conditions, product discontinuation, legislative requirements or other circumstances.

Visit our website to see the complete family of Palmer Hamilton products
800-788-1028 | www.palmerhamilton.com

70953

OF-RFNB6-PERF Spec 0824

