

LENOIR

Straight Lounge

PART #	DEPTH	WIDTH	SHAPE Straight S	BASE PRICE (add fabric)	UPGRADES (OPTIONAL; ADD SUFFIX IF ORDERED)						POWER		FABRIC ADDER									
					Half Back HBL (Left)	Half Back HBR (Right)	No Back NB	ARMS Left AL	Right AR	Both A2	Left PL	Right PR	Customer COM	Grade 2 G2	Grade 3 G3	Grade 4 G4	Grade 5 G5	Grade 6 G6	Grade 7 G7	Grade 8 G8	Grade 9 G9	Grade 10 G10
LN-LG-3036S	30	36	S	\$2,140	NA	NA	NC	\$362	\$362	NA	\$477	\$477	7 yards	\$210	\$413	\$616	\$826	\$1,029	\$1,232	\$1,442	\$1,694	\$1,953
LN-LG-3048S	30	48	S	\$2,282	NC	NC	NC	\$362	\$362	\$724	\$477	\$477	8 yards	\$240	\$472	\$704	\$944	\$1,176	\$1,408	\$1,648	\$1,936	\$2,232
LN-LG-3060S	30	60	S	\$2,987	NC	NC	NC	\$362	\$362	\$724	\$477	\$477	9 yards	\$270	\$531	\$792	\$1,062	\$1,323	\$1,584	\$1,854	\$2,178	\$2,511
LN-LG-3072S	30	72	S	\$3,237	NC	NC	NC	\$362	\$362	\$724	\$477	\$477	10 yards	\$300	\$590	\$880	\$1,180	\$1,470	\$1,760	\$2,060	\$2,420	\$2,790

Base model includes full back. Fabric grade must be added to that base price.

Arms are not available with Half Back (HBL) and No Back (NB) options. Order Both (A2) if arms on both sides are desired, not Left and Right.

NC = No Charge NA = Not Applicable

Product Sample

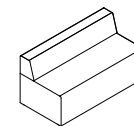

LN-LG-3060S

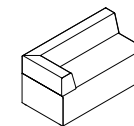

LN-LG-3060S-AL

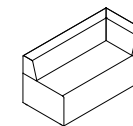

LN-LG-3060S-AR

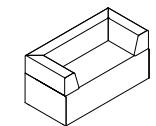

LN-LG-3060S-A2

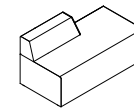

LN-LG-3060S-HBL

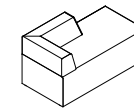

LN-LG-3060S-HBL-AL

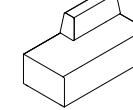

LN-LG-3060S-HBR

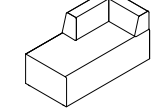

LN-LG-3060S-HBR-AR

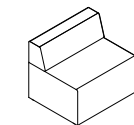

LN-LG-3036S

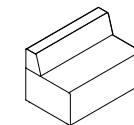

LN-LG-3048S

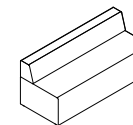

LN-LG-3072S

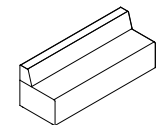

LN-LG-3084S

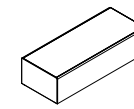

LN-LG-3072S-NB

Part Number Explanation:

LN-LG-3036S-A2-PL-G6

Fabric: COM = Customer furnished fabric (yardage shown)
 G2 = Grade 2 or G3 = Grade 3 or G4 = Grade 4 or G5 = Grade 5 or G6 = Grade 6
 or G7 = Grade 7 or G8 = Grade 8 or G9 = Grade 9 or G10 = Grade 10

Power Options: PL = Power on Left or PR = Power on Right

Arm Options: AL = Left or AR = Right or A2 = Both Sides

Full Back is Standard

Back Options: HBL = Half Back Left or HBR = Half Back Right

NB = No Back

Depth = 30" (only available depth)

Width = 36", 48", 60", or 72"

Shape: S = Straight

Brand: LN = Lenoir

Type: LG = Lounge

Fabric Combination Options

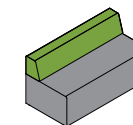

Seat 1 | Back 2

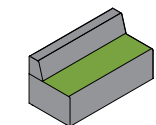

Main 1 | Seat Top 2

LENOIR

Curved Lounge

PART #	DESCRIPTION	DEPTH	RADIUS	BASE PRICE add fabric)	BACK Full Back (standard)	No Back NB	POWER Left PL	Right PR	FABRIC ADDER Customer COM	Grade 2	Grade 3	Grade 4	Grade 5	Grade 6	Grade 7	Grade 8	Grade 9	Grade 10
										G2	G3	G4	G5	G6	G7	G8	G9	G10
LN-LG-3060		30	60"															
LN-LG-3060IC	60" Radius, Inner Curve	30	60"	\$2,658	-	NC	\$477	\$477	8 yards	\$240	\$472	\$704	\$944	\$1,176	\$1,408	\$1,648	\$1,936	\$2,232
LN-LG-3060OC	60" Radius, Outer Curve	30	60"	\$2,596	-	NC	\$477	\$477	7 yards	\$210	\$413	\$616	\$826	\$1,029	\$1,232	\$1,442	\$1,694	\$1,953
LN-LG-3072		30	72"															
LN-LG-3072IC	72" Radius, Inner Curve	30	72"	\$2,658	-	NC	\$477	\$477	8 yards	\$240	\$472	\$704	\$944	\$1,176	\$1,408	\$1,648	\$1,936	\$2,232
LN-LG-3072IC	72" Radius, Outer Curve	30	72"	\$2,596	-	NC	\$477	\$477	7 yards	\$210	\$413	\$616	\$826	\$1,029	\$1,232	\$1,442	\$1,694	\$1,953

Fabric grade must be added to that base price.

Base model includes full back. Add suffix "NB" if No Back option is preferred

NC = No Charge NA = Not Applicable

Product Sample

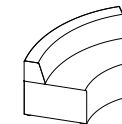

LN-LG-3060IC

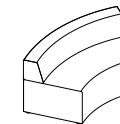

LN-LG-3072IC

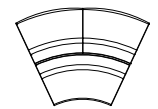

(1) Inner Curve to (2) Outer Curves

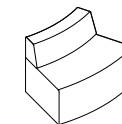

LN-LG-3060OC

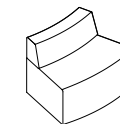

LN-LG-3072OC

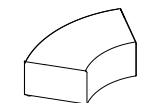

LN-LG-3060IC-NB

Part Number Explanation:

LN-LG-3060IC-NB-PL-G6



Fabric: COM = Customer furnished fabric (yardage shown)
 G2 = Grade 2 or G3 = Grade 3 or G4 = Grade 4 or G5 = Grade 5 or G6 = Grade 6
 or G7 = Grade 7 or G8 = Grade 8 or G9 = Grade 9 or G10 = Grade 10

Power Options: PL = Power on Left or PR = Power on Right

Full Back is Standard
 NB = No Back

Depth = 30" (only available depth)
 Radius: 60 = 60" Radius or 72 = 72" Radius
 Curve: IC = Inner Curve or OC = Outer Curve

Brand: LN = Lenoir
 Type: LG = Lounge

Fabric Combination Options

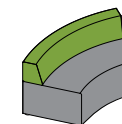

Seat 1 | Back 2

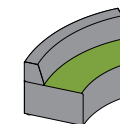

Main 1 | Seat Top 2

LENOIR

Rectangle Occasional Table

Upholstered table with laminated top and metal bun feet.

PART #	DEPTH	LENGTH	SHAPE Rectangle R	BASE PRICE (add fabric)	FABRIC ADDER Customer COM	Grade 2	Grade 3	Grade 4	Grade 5	Grade 6	Grade 7	Grade 8	Grade 9	Grade 10	LAMINATE	UPGRADE	
						G2	G3	G4	G5	G6	G7	G8	G9	G10	Group 2 L2	Group 3 L3	Group 4 L4
LN-OT-1824R	18	24	R	\$1,523	2.00 yards	\$60	\$118	\$176	\$236	\$294	\$352	\$412	\$484	\$558	\$25	\$40	\$85
LN-OT-1836R	18	36	R	\$1,709	2.50 yards	\$75	\$148	\$220	\$295	\$368	\$440	\$515	\$605	\$698	\$25	\$40	\$85
LN-OT-1848R	18	48	R	\$1,977	3.25 yards	\$98	\$192	\$286	\$384	\$478	\$572	\$670	\$787	\$907	\$30	\$50	\$95
LN-OT-1860R	18	60	R	\$2,401	4.25 yards	\$128	\$251	\$374	\$502	\$625	\$748	\$876	\$1,029	\$1,186	\$45	\$75	\$120

Fabric grade must be added to that base price.

Group 1 Laminate included in Base Price. Add upgrade price if desired.

Product Sample

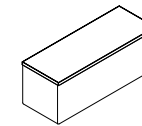

LN-OT-1848R

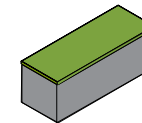

Base 1 | Top 2

Part Number Explanation:

LN-OT-1824R-G6-L3

- Laminate: L2 = Group 2 or L3 = Group 3 or L4 = Group 4
- Fabric: COM = Customer furnished fabric (yardage shown)
- G2 = Grade 2 or G3 = Grade 3 or G4 = Grade 4 or G5 = Grade 5 or G6 = Grade 6 or G7 = Grade 7 or G8 = Grade 8 or G9 = Grade 9 or G10 = Grade 10
- Depth = 18" (only available depth)
- Length = 24", 36", 48", or 60"
- Shape: R = Rectangle
- Brand: LN = Lenoir
- Type: OT = Occasional Table

LENOIR

Round Occasional Table

Upholstered table with laminated top and metal bun feet.

PART #	HEIGHT	DIAMETER	SHAPE Round D	BASE PRICE (add fabric)	FABRIC ADDER Customer COM	Grade 2	Grade 3	Grade 4	Grade 5	Grade 6	Grade 7	Grade 8	Grade 9	Grade 10	LAMINATE	UPGRADE	Group 4
						G2	G3	G4	G5	G6	G7	G8	G9	G10	Group 2 L2	Group 3 L3	Group 4 L4
LN-OT-18D	18	18	D	\$1,526	2.00 yards	\$60	\$118	\$176	\$236	\$294	\$352	\$412	\$484	\$558	\$25	\$40	\$85
LN-OT-24D	18	24	D	\$1,713	2.50 yards	\$75	\$148	\$220	\$295	\$368	\$440	\$515	\$605	\$698	\$25	\$40	\$85
LN-OT-30D	18	30	D	\$1,892	2.75 yards	\$83	\$162	\$242	\$325	\$404	\$484	\$567	\$666	\$767	\$30	\$50	\$95
LN-OT-36D	18	36	D	\$2,138	3.25 yards	\$98	\$192	\$286	\$384	\$478	\$572	\$670	\$787	\$907	\$65	\$110	\$215
LN-OT-42D	18	42	D	\$2,462	4.00 yards	\$120	\$236	\$352	\$472	\$588	\$704	\$824	\$968	\$1,116	\$120	\$160	\$245

Fabric grade must be added to that base price.

Group 1 Laminate included in Base Price. Add upgrade price if desired.

Product Sample

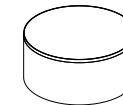

LN-OT-30D

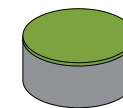

Base 1 | Top 2

Part Number Explanation:

LN-OT-18D-G6-L3

Laminate: L2 = Group 2 or L3 = Group 3 or L4 = Group 4

Fabric: COM = Customer furnished fabric (yardage shown)

G2 = Grade 2 or G3 = Grade 3 or G4 = Grade 4 or G5 = Grade 5 or G6 = Grade 6
or G7 = Grade 7 or G8 = Grade 8 or G9 = Grade 9 or G10 = Grade 10

Diameter = 18", 24", 30", 36", or 48"

Shape: D = Round

Brand: LN = Lenoir

Type: OT = Occasional Table

LENOIR

Square Occasional Table

Upholstered table with laminated top and metal bun feet.

PART #	HEIGHT	LENGTH	SHAPE Square S	BASE PRICE (add fabric)	FABRIC ADDER Customer COM	Grade 2	Grade 3	Grade 4	Grade 5	Grade 6	Grade 7	Grade 8	Grade 9	Grade 10	LAMINATE	UPGRADE	Group 4
						G2	G3	G4	G5	G6	G7	G8	G9	G10	Group 2 L2	Group 3 L3	Group 4 L4
LN-OT-18S	18	18	S	\$1,538	2.25 yards	\$68	\$133	\$198	\$266	\$331	\$396	\$464	\$545	\$628	\$25	\$40	\$85
LN-OT-24S	18	24	S	\$1,726	2.75 yards	\$83	\$162	\$242	\$325	\$404	\$484	\$567	\$666	\$767	\$25	\$40	\$85
LN-OT-30S	18	30	S	\$1,920	3.00 yards	\$90	\$177	\$264	\$354	\$441	\$528	\$618	\$726	\$837	\$30	\$50	\$95
LN-OT-36S	18	36	S	\$2,150	3.50 yards	\$105	\$207	\$308	\$413	\$515	\$616	\$721	\$847	\$977	\$65	\$110	\$215
LN-OT-42S	18	42	S	\$2,475	4.25 yards	\$128	\$251	\$374	\$502	\$625	\$748	\$876	\$1,029	\$1,186	\$120	\$120	\$245

Fabric grade must be added to the base price.

Group 1 Laminate included in Base Price. Add upgrade price if desired.

Product Sample

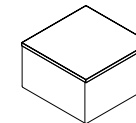

LN-OT-30S

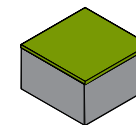

Base 1 | Top 2

Part Number Explanation:

LN-OT-18S-G6-L3

Laminate: L2 = Group 2 or L3 = Group 3 or L4 = Group 4

Fabric: COM = Customer furnished fabric (yardage shown)

G2 = Grade 2 or G3 = Grade 3 or G4 = Grade 4 or G5 = Grade 5 or G6 = Grade 6
or G7 = Grade 7 or G8 = Grade 8 or G9 = Grade 9 or G10 = Grade 10

Diameter = 18", 24", 30", 36", or 48"

Shape: S = Square

Brand: LN = Lenoir

Type: OT = Occasional Table

LENOIR

Example Layouts

Mix Lenoir seats with arms, half back and tables

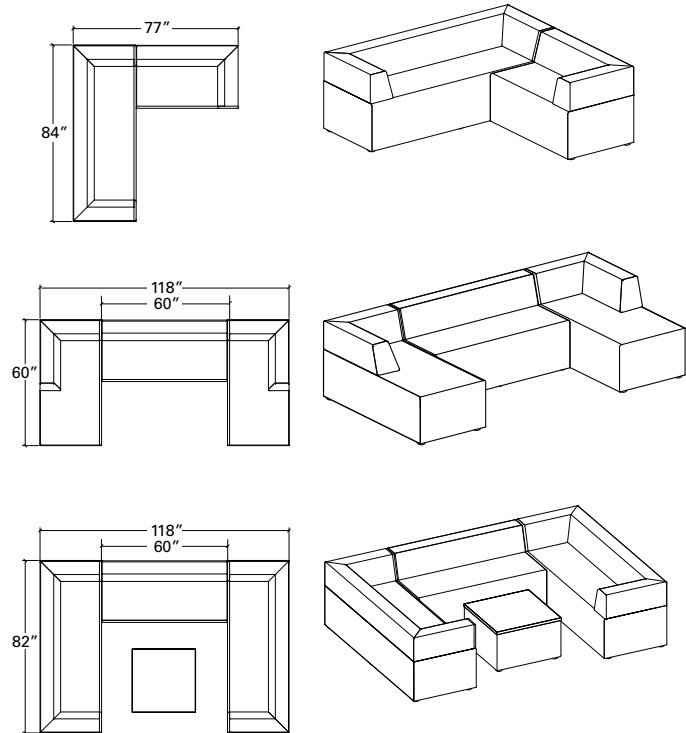

Coordinate with Blueridge shelving

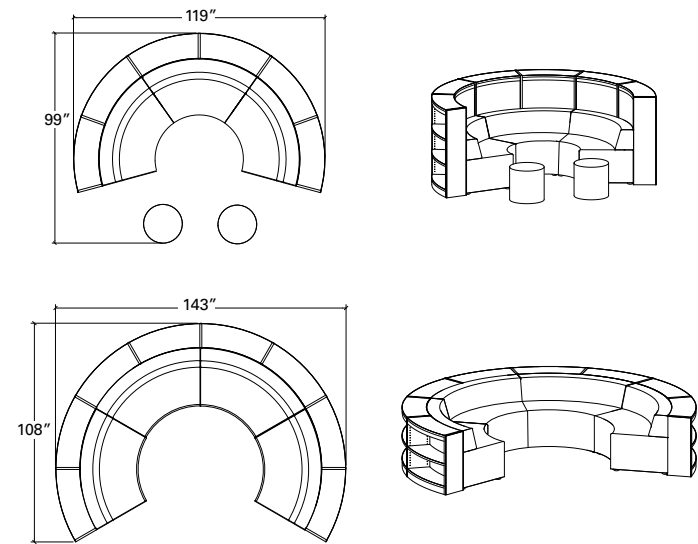

LENOIR

Material Details

LAMINATES

Group 1: Choose your colors from Wilsonart® laminates. See their website. Palmer Hamilton standards are most colors in Type 335 laminate and finish type ending in -38 or -60. Exceptions apply, including colors that begin with "Y" or end with K-38 or K-60.

Group 2: Standard Pionite®, Nevamar® and Formica® laminates, and non-standard Wilsonart® laminates Type 335 and 107 Recycled Content, and finish types not ending in -38 or -60.

Group 3: Wilsonart® Specialty Types 136 / 137 Chalkboard Laminates, and premium Aborite®, Pionite®, Nevamar®, and Formica®

Group 4: Non-Standard Premium Wilsonart® Laminate Types 362 (VDL, Y-Type), 156/336 (Markerboard), 376-HD / 366 Wilsonart® HD, and 515 Compact Laminate.

All premium laminates are subject to an upcharge. Contact Palmer Hamilton with questions.

PVC EDGING

We frequently update our edge color options to meet customer tastes and style changes. Please check the "Edges" page on our website for the latest options available.

Custom edge colors may be available, please call for availability and pricing. Minimums may apply.

FABRICS

Only fabrics Grade 2 or higher can be used reliably for our upholstered pieces. Add fabric adder price to Base Price.

See our website Fabrics page for the approved brands and fabrics we recommend.

Customer provided fabrics (COM) need to be approved. Send sample swatch to:

Upholstery Department
PALMER HAMILTON
143 S Jackson Street
Elkhorn, WI 53121-1911