

## HAYWOOD

Haywood's clean angular design works as a modular system with limitless combinations in lounge seating.



### FEATURES

- Wide array of shapes for flexible design options. Straight and curved modular pieces, with or without arms, power options.
- Fabric covered ottomans coordinate with seating options to add comfort and conversational interest.
- Line includes occasional tables with laminate tops to sit next to or in the middle of a seating section. Designed to fit into a line of seats, straight and angled pieces allow for unique lounge configurations.
- Metal legs with glides lift furniture off the floor, and move easily to make cleaning around and under the furniture simple.
- Choose from Palmer Hamilton's wide array of upholstery fabrics and laminates for table tops with matching PVC edging.
- Materials have been selected for longevity and comfort.

### SEATING MATERIALS

- The lounge frames are constructed of

puzzle cut 7/8" thick plywood with finger joints stapled together.

- The seat uses 8 gauge no sag sinuous springs with 4" thick high density polyurethane foam.
- The backs uses 11 gauge no sag sinuous springs with 2" thick high density polyurethane foam.
- The arms are covered with 1/4" thick high density polyurethane foam.
- Fabrics of Grade 2 or higher are recommended. Selections up to Grade 10 available. Options include over 50 standard fabrics and hundreds of designer fabrics to choose from. See our website for selections.
- Because of the curved and angular design of the back, seat and table or ottoman pieces, patterned fabrics are not recommended.
- Contrasting fabrics are available for all upholstered modules. When selecting contrasting upholstery, clearly specify

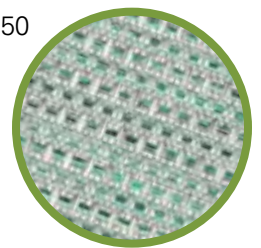

Occasional tables in multiple shapes offer interesting joining options between the soft seating.

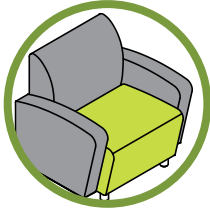

which fabric should be used for the base, seat, back, and arms. See our price list for allowed combinations. Use the higher grade for pricing purposes.

- Typically we use fabric "Up the Roll" with any stripes/pattern going from front to back. Please contact us with any special requests or instructions.

### COM FABRIC POLICY

- We accept Customer Own Material (COM) with some restrictions.
- A sample swatch should be sent to Upholstery Department  
**PALMER HAMILTON**  
143 S. Jackson Street  
Elkhorn, WI 53121-1911  
We'll contact you with our approval or questions.
- All yardage requirements for COM are based upon 54" plain non-direction material. Additional yardage may be required based on repeat and matching.
- See the price list for required yardage for each module. Additional yardage will be required for patterned fabrics, per this list:

REPEAT	Additional yardage
Based on 54" wide roll	
Plain fabric	0%
1-5" repeat	10%
6-10" repeat	15%
11-15" repeat	20%
16-20" repeat	25%
21-30" repeat	30%
31-40" repeat	40%
41"+ repeat	50%

Based on 54" wide roll

Call us for assistance with any questions.

- Palmer Hamilton takes no responsibility for tailoring, wear-ability or application of COM fabrics and textiles. Any warranty claims will fall to the original vendor of the material.

### FEET ON SEATING AND TABLES

- Metal legs are 3" tall, 1-11/16" diameter turned aluminum with securely attached to furniture frame with a sturdy metal threaded rod.
- Legs have non-marking glides on bottom to protect floors and make moving easy.
- Legs are attached to furniture base with a sturdy metal plate secured with screws.



Curves and pie shape end pieces create seating options with inventive layouts.



## OTTOMANS & OCCASIONAL TABLES

- All sections are built of 7/8" thick plywood with finger joint construction that is stapled.
- Ottoman units are tops and sides are covered with high density polyurethane foam, covered by upholstery fabrics. Tops have 4" foam, and sides are 1/4".
- Sides of occasional tables are covered with .25" thick high density polyurethane foam, covered by upholstery fabrics.
- The occasional table tops are constructed of 1-1/8" particle board core with high pressure laminate on both faces and a 3mm PVC external band on all visible edges.
- Occasional tables tops have Grade 1 laminate tops as standard, with options for higher grades, upcharges per the price list. See our website for options.

## Laminates

- **Group 1:** Choose your colors from Wilsonart® laminates. See their website. Palmer Hamilton standards are most colors in Type 335 laminate and finish type ending in -38 or -60. Exceptions apply, including colors that begin with "Y" or end with K-38 or K-60.
- **Group 2:** Standard Pionite®, Nevamar®, and Formica® laminates, and non-standard Wilsonart® laminates Type 335 and 107

Recycled Content, and finish types not ending in -38 or -60.

- **Group 3:** Wilsonart® Specialty Types 136 / 137 Chalkboard Laminates, Arborite®, and premium Pionite®, Nevamar®, and Formica®
- **Group 4:** Non-Standard Premium Wilsonart® Laminate Types 362 (VDL, Y-Type), 156/336 (Markerboard), 376-HD / 366 Wilsonart® HD, and 515 Compact Laminate.
- **All premium laminates** are subject to an upcharge. Contact Palmer Hamilton with questions.



## POWER

- The power strip includes (1) Tamper-Resistant (TR) AC outlet (1) USB Type-A charging port: 5V 2.1A (10.5W), and (1) USB Type-C charging port: 5V 2.4A (12W).
- The bevel-edged mounted faceplate is powder-coated black or white with color matched receptacles.
- Power units have 10-foot cord.
- Power units available on front of arms or side of seat.

## WARRANTY

See our website.

## SHIPPING

Ship assembled. Feet are field attached.

Contrasting fabrics add vibrancy to lounge furniture.



## Upholstered Back Seating

### Fabric Combination Options

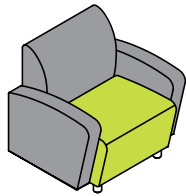

Arms & Back 1 | Seat 2

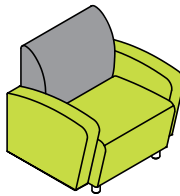

Back 1 | Seat & Arms 2

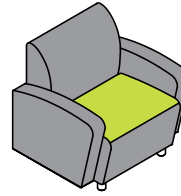

Main 1 | SeatTop 2

## Dimensions

### Straight Shape Chairs

#### No Arms

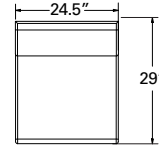
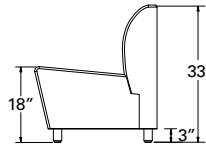
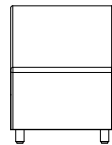
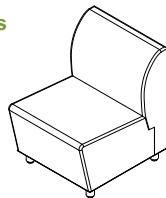

#### One Arm (left or right)

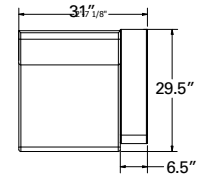
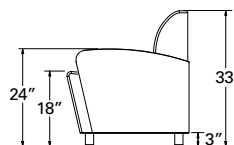
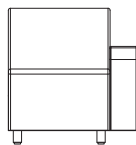
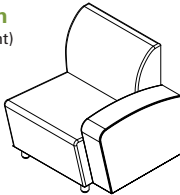

#### Two Arms

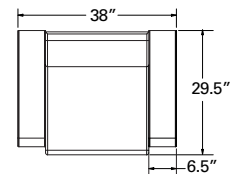
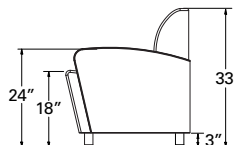
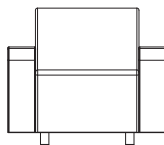
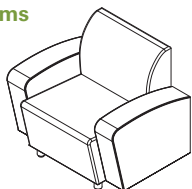

**Upholstered Back Seating**

**Dimensions**

**22° Outer Curve Chairs**

**No Arms**

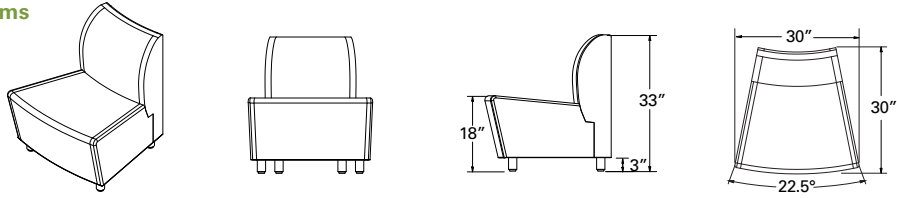

**One Arm**  
(left or right)

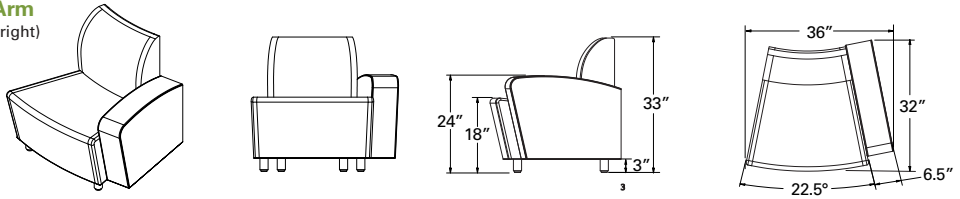

**Two Arms**

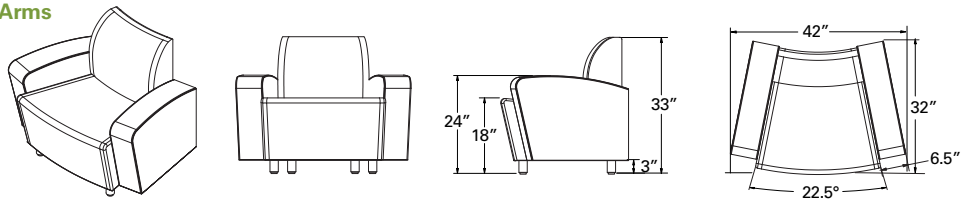

**Dimensions**

**22° Inner Curve Chairs**

**No Arms**

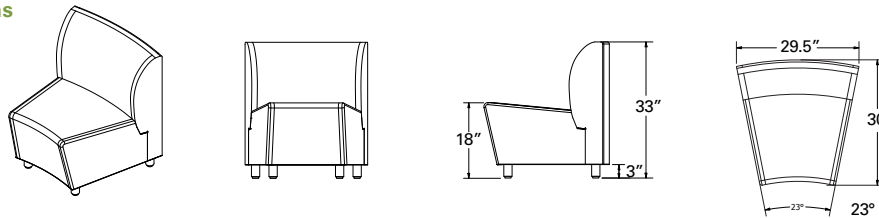

**One Arm**  
(left or right)

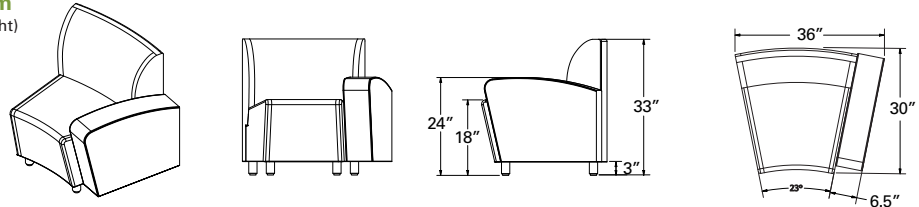

**Two Arms**

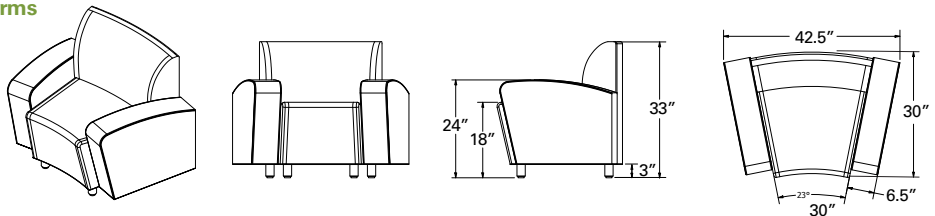

**Upholstered Back Seating**

**Dimensions**

**45° Outer Curve Chairs**

**No Arms**

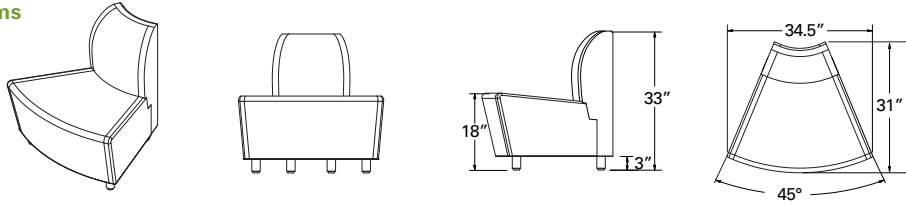

**One Arm**  
(left or right)

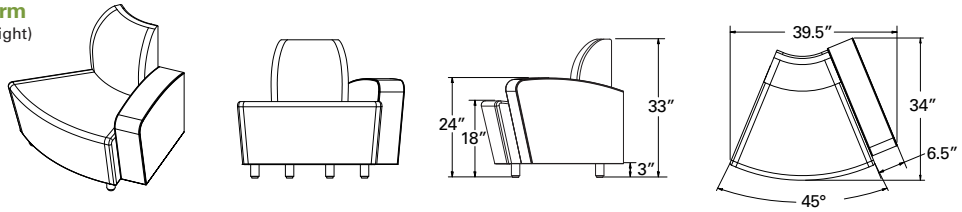

**Two Arms**

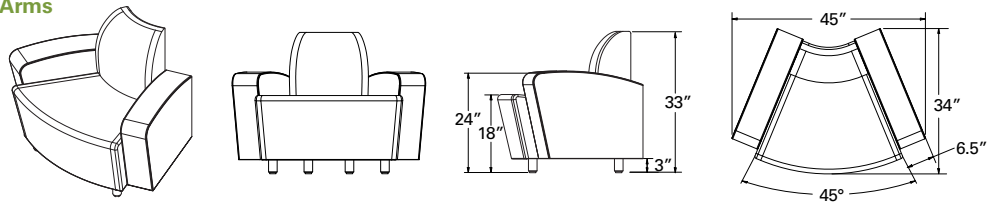

**Dimensions**

**45° Inner Curve Chairs**

**No Arms**

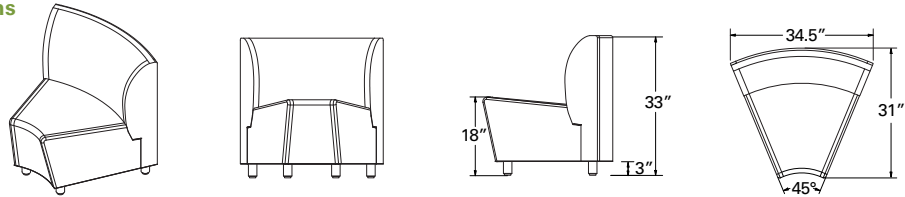

**One Arm**  
Left or Right

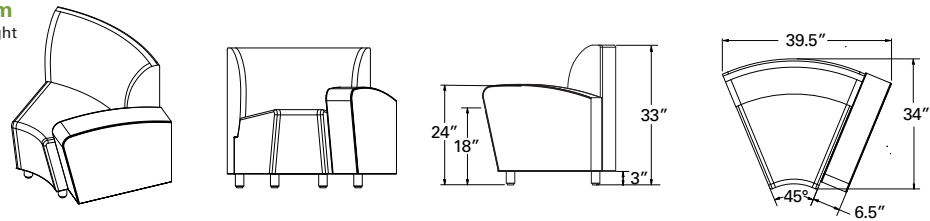

**Two Arms**

Not available on this model

**Upholstered Ottoman**

**Dimensions**

**Oval Ottoman**

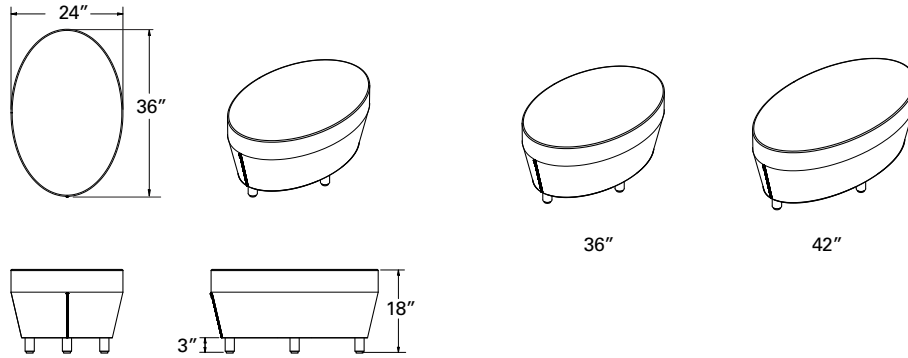

**Dimensions**

**Round Ottoman**

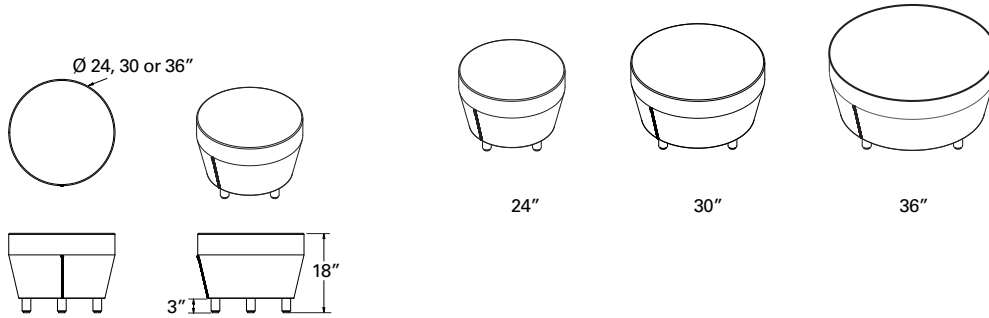

**Dimensions**

**Square Ottoman**

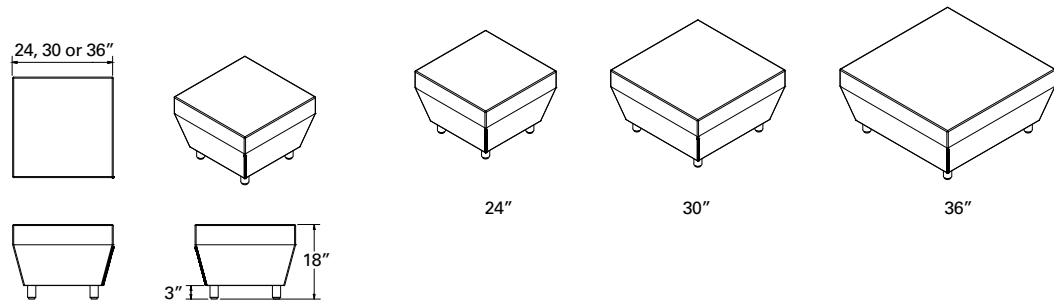

**Occasional Tables**

Upholstered base with laminated top

**Dimensions**

**Oval Tables**

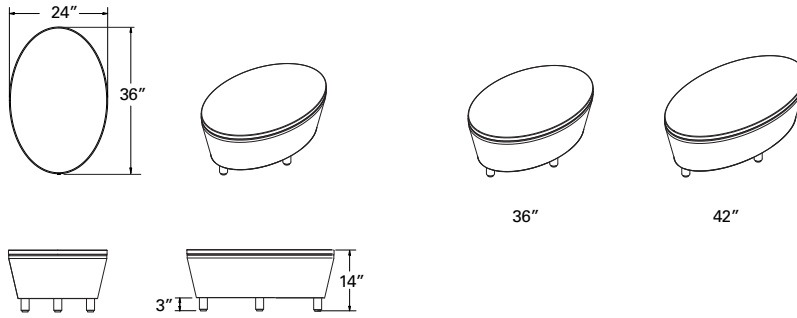

**Round Tables**

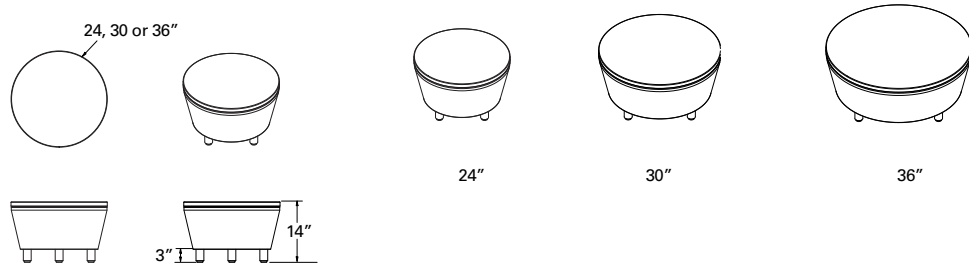

**Square Tables**

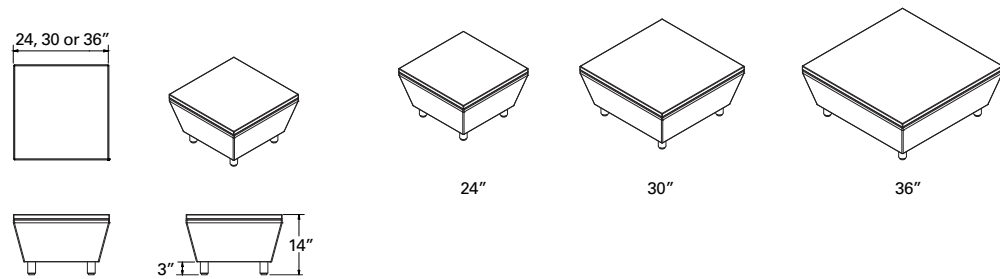

**Occasional Linking Tables**

Upholstered base with laminated top

**Dimensions**

**Square Linking Tables**

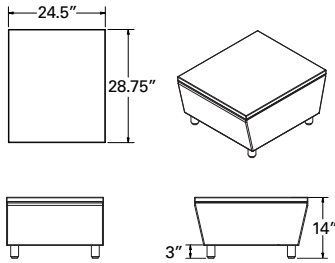

**Double Depth, Square Linking Tables**

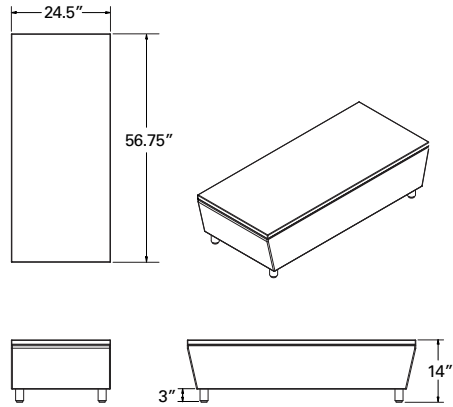

**Wedge Linking Tables**

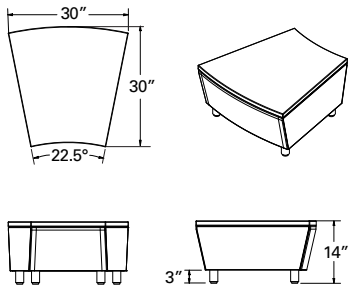

**Double Depth, Wedge Linking Tables**

