

CENTRA

A rugged, sturdy, and modern steel frame with laminate tops or recycled HDPE for indoor and long-lasting outdoor use.

Available as tables, benches, or picnic tables with attached seating.



FEATURES

- All tables are 30" wide, available in 72" or 96" lengths. See material descriptions for indoor and outdoor models.
- Freestanding tables available in 30" and 42" heights.
- Benches are 17" high, 15" width. Multiple bench lengths – 30", 42", 72", or 96" – accommodate individual seats, wheelchair and other seating options.
- Wheelchair access for 30"H tables only.
- Picnic style tables with attached benches are available in 72" and 96" lengths.
 - Frames engineered to withstand weight without sagging. 96" benches have center pin leg. Crossbars and angled framework ensure stability.
 - Designed to coordinate with other modern seating options, including some of Palmer Hamilton's chairs and stools.
- Glides and casters on indoor furnishings make sturdy furniture also easy to move for cleaning and reorganization of space.
- Glides and anchors for outdoor use, offering the option of permanent seating arrangement.

SIZE OPTIONS

- 6' and 8' tables lengths with or without attached benches (picnic style tables).
- 30" table width.
- 30" and 42" table heights.
- 30", 42", 72", and 96" bench lengths.

CONFIGURATIONS

- Connected or stand alone benches.
- Shorter benches provide versatile seating arrangements, allowing accommodation for wheelchairs in ADA-compliant spaces.
- Tables available in both standard and pub heights pair well with chairs or stools. The streamlined design complements our Jackson, Encore, and other collections.

FRAMES

- Our tables have self-supporting, MIG welded, unitized frame design.
- Boards are mounted to a 14 gauge formed steel apron. Top is then bolted to an A-frame style leg constructed of 16 gauge, 2" square tubing.
- 96"L benches have a middle pin leg for added support. Center legs are constructed of the same square tubing as frame.

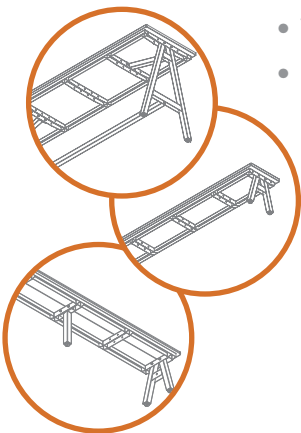

Indoor and outdoor seating in multiple configurations with a modern, industrial style.



- All metal parts are thoroughly cleaned to resist corrosion and provide maximum paint adhesion, finished with high-grade electrostatically applied baked-on epoxy powdercoat for superior resistance to abrasion, marring and scratching. The finish is a lightly textured polyester powder coating.
- The durable finish is available in our standard three options, and ten custom frame colors. See our website for non-standard colors. Minimum orders apply. Upcharge may apply.



Black Textured
(BLK)



Chameleon Textured
(CHA)



Metallic Silver
(MS)

TOPS AND BENCHES

Indoor Tops and Benches

Our tables and benches are built with materials we've determined are the best for our applications. These materials are industry standards, tested and compliant.

- Tops and benches are 1-1/8" M3 industrial grade particle board of 100% recycled/recovered wood content.
- Tested in accordance with ANSI 208.1 – 2022
- EPA TSCA Title IV certified. Complies with CARB ATCM 93T20

- 0.30" HPL decorative laminate on top side.
- .028" balanced black backer on bottom of table core for stability and moisture resistance.
- Table and bench have 1/2" radius corners.

CENTRA offers a full choice of our standard laminate options for indoor applications. Group 1 laminates are included in our base price.

- **Group 1:** Choose your colors from Wilsonart® or Formica® laminates. See their websites for selections. For Wilsonart®, our standards are most colors in Type 335 laminate and finish type ending in -38 or -60. Exceptions apply, including colors that begin with "Y" or end with K-38 or K-60. Standard Formica® Laminates are Grade 12 or Grade 20 ending in finish type -58 and -43.
- **Group 2:** Standard Pionite®, Nevamar®, and non-standard Wilsonart® laminates Type 335 and 107 Recycled Content, and finish types not ending in -38 or -60.
- **Group 3:** Wilsonart® Specialty Types 136 / 137 Chalkboard Laminates, Arborite®, and premium Formica®, Pionite®, and Nevamar®.
- **Group 4:** Non-Standard Premium Wilsonart® Laminate Types 362 (VDL, Y-Type), 156/336 (Markerboard), 376-HD / 366 Wilsonart® HD, and 515 Compact Laminate.

Use one or multiple benches to vary seating options, including wheelchair access..



- **All premium laminates** are subject to an upcharge. Please contact Palmer Hamilton with questions regarding laminate selection.
- **Mix colors:** table tops and benches can be of different colors on picnic model units as well as individually ordered tables and benches.

- **Custom logo laminates** are available on table tops only at an upcharge.



- **Butcher Block wood** is also available for tops and benches. Material is 1 1/8" thick face-glued, finger joint rails finished with a clear catalyzed lacquer.

Wood consists of standard mixed hardwoods which are a variation of different species containing similar color and grain patterns. Edge profile is 1/8" eased edge.

Laminate Edge Options

- Our standard edge is EdgeGuard™, a sprayed-on polyurea eased edge treatment that provides superior resistance to moisture, eliminates unsanitary food traps, and is extremely tamper resistant. Edges stay sealed, preventing peeling and chipping. Durable for many years of use.



EdgeGuard™

- Optional edge is a 3mm flat PVC edge, adhered to the particle board for a tight bond, available in fashion colors.
- See our website page "Edges" for colors.

Indoor/Outdoor Tops and Benches



PVC

- Palmer Hamilton has selected a tough performance High Density Polyethylene (HDPE) recycled lumber for our CENTRA line.
- 1-1/2" thick material is available in standard width planks, or 3/4" thick for variable width table top boards with coordinating bench design.
- Material includes UV inhibitors to prevent fading, assuring long lasting color.
- The matte finish makes surfaces easily cleanable and resilient against vandalism.
- 100% recyclable.
- Outdoor material available in 12 neutral and 10 bright colors. Minimums may apply.
- Recycled poly picnic tables and benches must be of one color only.

Long lasting HDPE material for use outdoors.



HDPE poly colors

Standard colors

Available for standard delivery; no minimums.

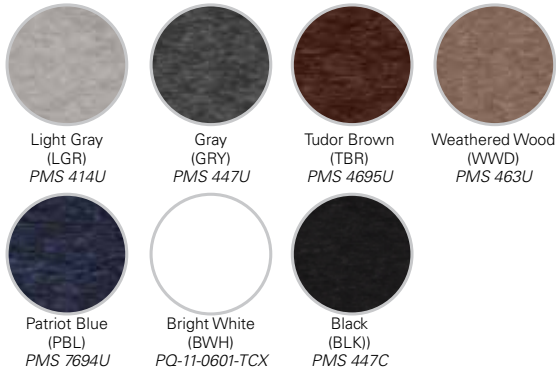

Custom colors

No minimums, but longer lead times may apply.

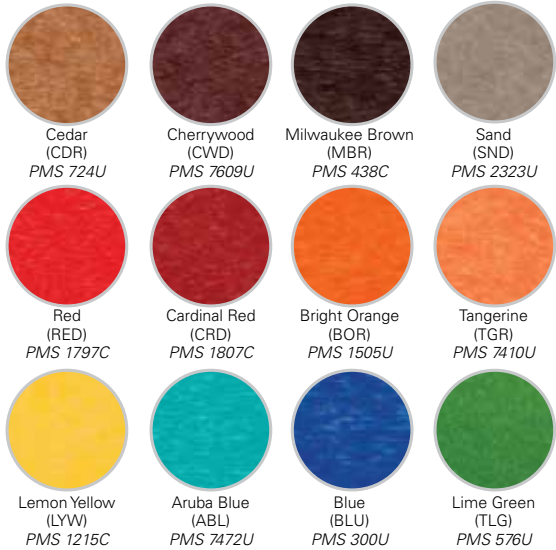

Limited colors

Infrequent production; call for availability.

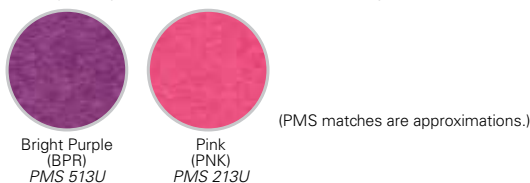

Indoor/Outdoor Tops and Benches

- HDPE boards have bullnosed edges and small spaces between boards.

Picnic table style

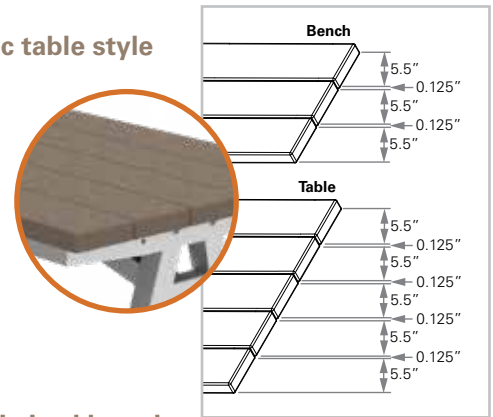

Multi-sized boards

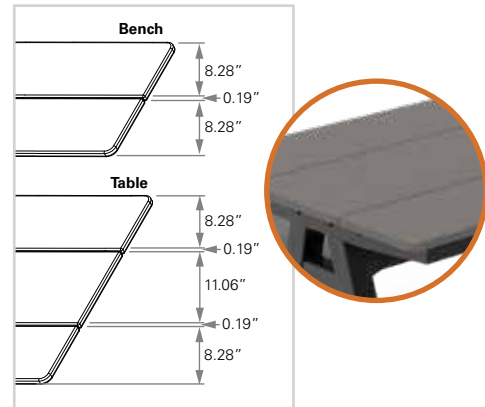

Options for anchors or glides, or casters for tables extend configurations indoors or out.



FOOT OPTIONS



Anchor

Glide



Caster (tables only)

- Freestanding units with glides standard on all models. Heavy duty locking caster option for indoor table use, or anchor option for secured applications.
- Only anchor plates are provided. Anchor bolts to be provided by customer.
- Casters not available on benches.
- Benches can be anchored into position.

UMBRELLA HOLES

All 30" high tables in HDPE material have a centered umbrella hole.

WEIGHT CAPACITY

See chart on page 7 for number of seats per bench, based on approximately 250 lb per person.

CERTIFICATIONS

- HDPE Dimensional Lumber is 71% recycled content, and meets standards for a 9% Closed Loop Material, qualifying it for Green Circle Certification®.

SHIPPING

All models ship KD. Legs, glides, casters or anchors need to be attached.

WARRANTY

See our website for warranty details.

Versatile industrial design that coordinates with other seating options.



DIMENSIONAL DRAWINGS

Benches

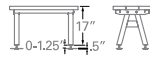
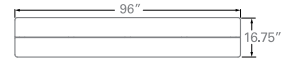
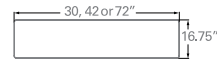
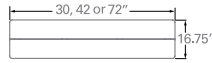
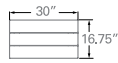

HDPE BENCH WITH ANCHORS



HDPE BENCH WITH GLIDES



BENCH WITH GLIDES



96" BENCH with pin leg

Indoor Tables

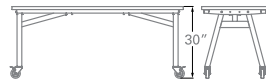
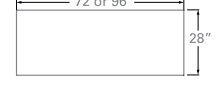
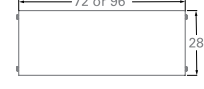
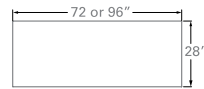
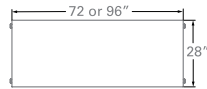

TABLE WITH CASTERS

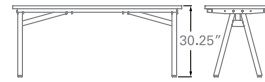

TABLE WITH GLIDES



TALL TABLE WITH CASTERS



TALL TABLE WITH GLIDES

Outdoor Tables

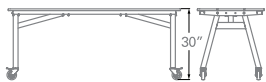
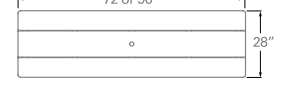
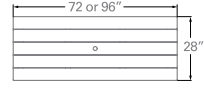
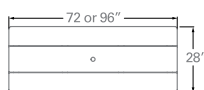
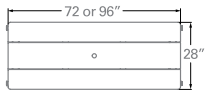

TABLE WITH CASTERS

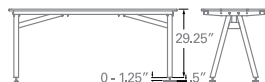

TABLE WITH ANCHORS



TALL TABLE WITH ANCHORS



TALL TABLE WITH GLIDES

Picnic Tables

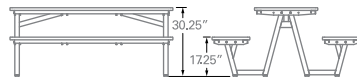
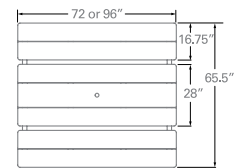
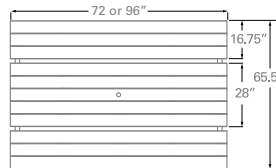
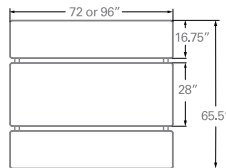

LAMINATE PICNIC TABLE WITH GLIDES

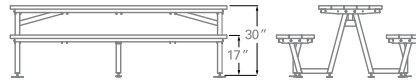

HDPE PICNIC TABLE WITH GLIDES
Note: 72" bench has no center pin leg

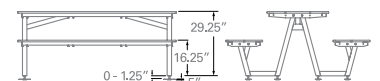

HDPE PICNIC TABLE WITH ANCHORS
Note: 96" bench has center pin leg



SPECIFICATIONS

MODEL NUMBER	DESCRIPTION	TABLE DIMENSIONS H x W x L (in)	FOOTPRINT (in)	SEATING CAPACITY Adult/Child	PRODUCT WEIGHT (lbs)*				SHIPPING DIMS + W x D x H (in)	SHIPPING WEIGHT (lb) +			
					LM	BB	MB	RP		LM	BB	MB	RP
CEN24303072A	Picnic Table, attached Benches	30 x 28 x 72	65.5 x 72	6 / 8	253	250	229	297	17 x 30 x 72	320	317	296	364
CEN24303096A	Picnic Table, attached Benches	30 x 28 x 96	65.5 x 96	8 / 10	320	316	287	378	17 x 30 x 96	409	405	376	467
CEN24303072T	Table	30 x 28 x 72	28 x 72		122	120	111	141	14 x 30 x 72	194	192	183	213
CEN24303096T	Table	30 x 28 x 96	28 x 96		150	148	135	176	14 x 30 x 96	244	242	229	270
CEN24423072T	Table	42 x 28 x 72	28 x 72		142	141	131	161	14 x 30 x 72	214	213	203	233
CEN24423096T	Table	42 x 28 x 96	28 x 96		174	172	159	200	14 x 30 x 96	268	266	253	294
MODEL NUMBER	DESCRIPTION	BENCH DIMENSIONS H x W x L (in)	FOOTPRINT (in)	SEATING CAPACITY per bench Adult/Child	PRODUCT WEIGHT (lbs)*				SHIPPING DIMS W x D x H (in)	SHIPPING WEIGHT (lb) +			
					LM	BB	MB	RP		LM	BB	MB	RP
CEN24171730B	30" Bench	17 x 16.75 x 30	16.75 x 30	1 / 1	38	36	36	43	14 x 30 x 72	110	108	108	115
CEN24171742B	42" Bench	17 x 16.75 x 42	16.75 x 42	1 / 2	48	48	44	55	14 x 30 x 72	120	120	116	127
CEN24171772B	72" Bench	17 x 16.75 x 72	16.75 x 72	3 / 4	71	71	65	83	14 x 30 x 72	143	143	137	155
CEN24171796B	96" Bench	17 x 16.75 x 96	16.75 x 96	4 / 6	90	89	82	196	14 x 30 x 96	184	183	176	200

* Product weights listed are approximate.

+ Shipping Dimensions and Weights are based on one item and are for rough estimation only. Typically tables are shipped in bulk and packaged in the most efficient method.

LM = Laminate

BB = Butcher Block

MB = Multi-sized Boards

RP = Recycled Poly

LAMINATE CARE AND CLEANING

- Use mild soap and water, damp sponge or non-abrasive cloth for general cleaning.
- Avoid abrasive pads and cleaners, acidic or alkali based cleansers.
- Stubborn marks may require alcohol or acetone.
- **DO NOT** power wash.
- For detailed instructions, see cleaning instructions on the websites for Wilsonart® or Formica® laminates.

HDPE CARE AND CLEANING

- Scrub boards with soap and water solution using a soft sponge or plastic-bristled brush.
- Use a soft-bristled toothbrush to clean hard to reach spaces.
- To remove surface dust, wash with cold, clear water.
- A pressure washer can be used on the lightest setting to deep clean the furniture. Use setting of 1,500psi or less.
- Keep tip of pressure washer at least 10-12 inches from surface to avoid damage.

HDPE STAIN TREATMENT CHART

- Always read and follow the product manufacturers' specific instructions before using any cleaning product. Always wear approved safety glasses, gloves, face shield or goggles when operating cleaning equipment. If using alternative cleaning solutions than those outlined below, it is recommended to test the solution on an inconspicuous area of the lumber to make sure it does not harm the surface.

Pencil Marks	Use a mild dish detergent and water to saturate the stain. Rinse clean with water.
Ink/Marker	Use a mild dish detergent and water to saturate the stain. Rinse clean with water. For tougher stains, treat area with a penetrating oil. Wipe off and wash clean with water and a mild dish detergent.
Grease or Oil Stain	Use a mild dish detergent and water to saturate the stain. Rinse clean with water.
Embedded Dirt	Use a mild dish detergent to saturate the area. Scrub with a soft-bristled brush. Rinse clean with water.
Chewing Gum	Coat penetrating oil over the area. Gently pry up on any hard pieces with a plastic putty knife. Utilize a soft brush and acetone solvent to remove any fine debris and clean out any crevasses. Rinse area clean with water.
Bird Droppings	Use a mild dish detergent to saturate the area. Scrub with a soft-bristled brush and rinse clean with water.
Stains and Scuffs	A foam eraser sponge may be used for stubborn marks.
Iron and Rust	For tough iron and rust stains, saturate with a heavy-duty rust remover and scrub with a soft-bristled brush.