

RFP4
4' PERSONALIZED DIAMOND BENCH - surface mount

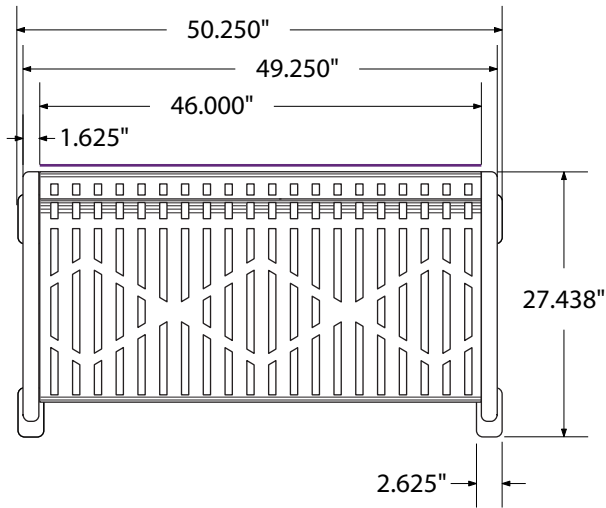

Top view



Front view

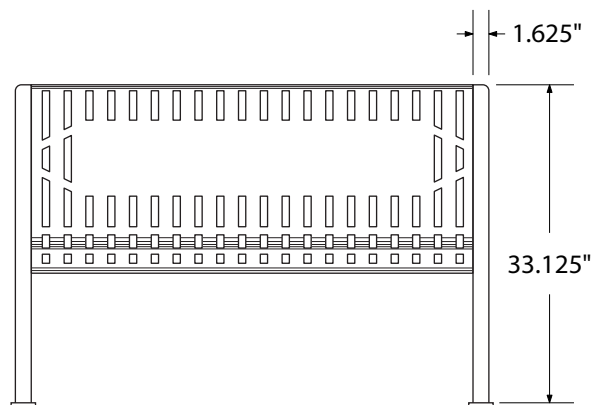

Side view

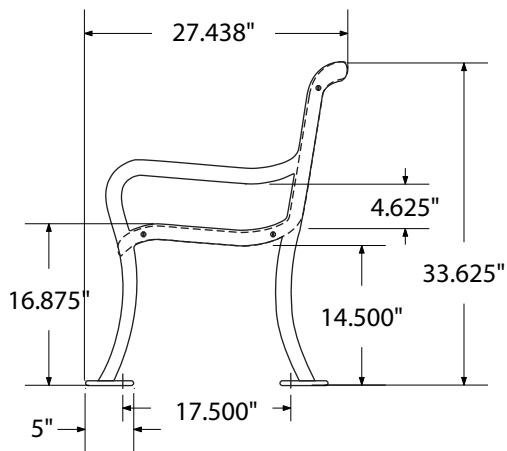

Product finish



Coated Surfaces

- Thermoplastic coated
- Copolymer-based, environmentally safe
- Does not fade, crack, peel, or warp
- Applied at a thickness 25-30 mils
- 5 year warranty on coating

Construction

- Seat and back - 11 gauge steel
- Cast iron leg structures
- Galvanized hardware

Mounting style

P = Portable: no mount

SM = Surface Mount:
concrete anchors through
holes in feet

IG = In-Ground: J-rods set
in concrete through holes in
feet

Portable

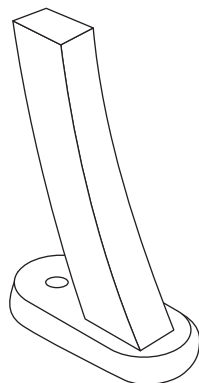

Surface Mount

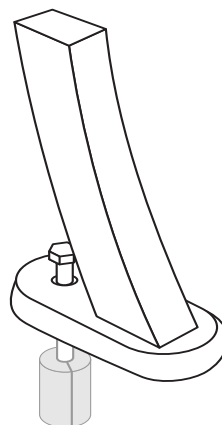

In-ground

