

RFP8
8' PERSONALIZED DIAMOND BENCH

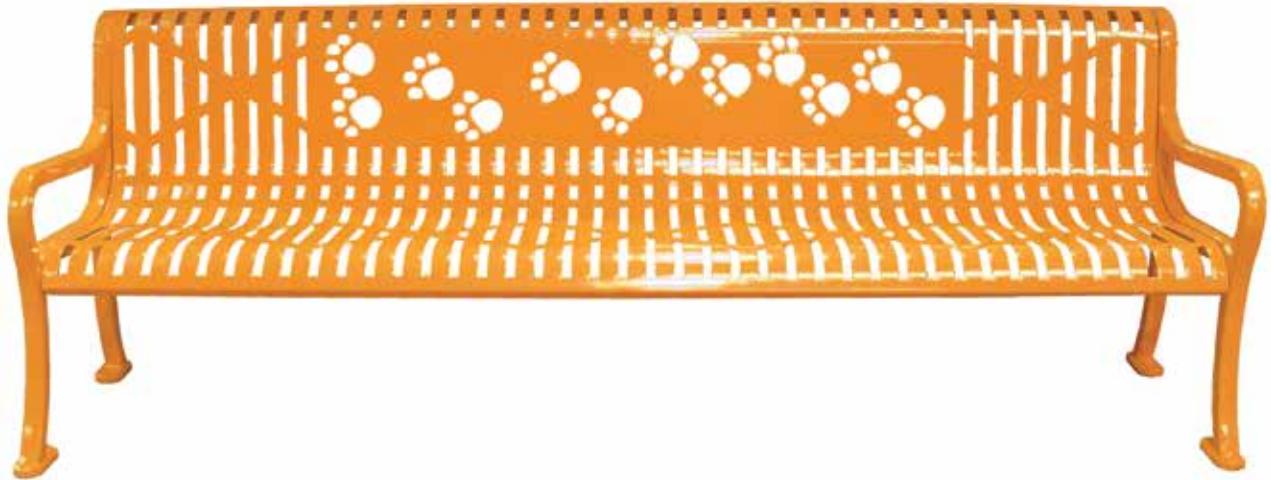

Top view

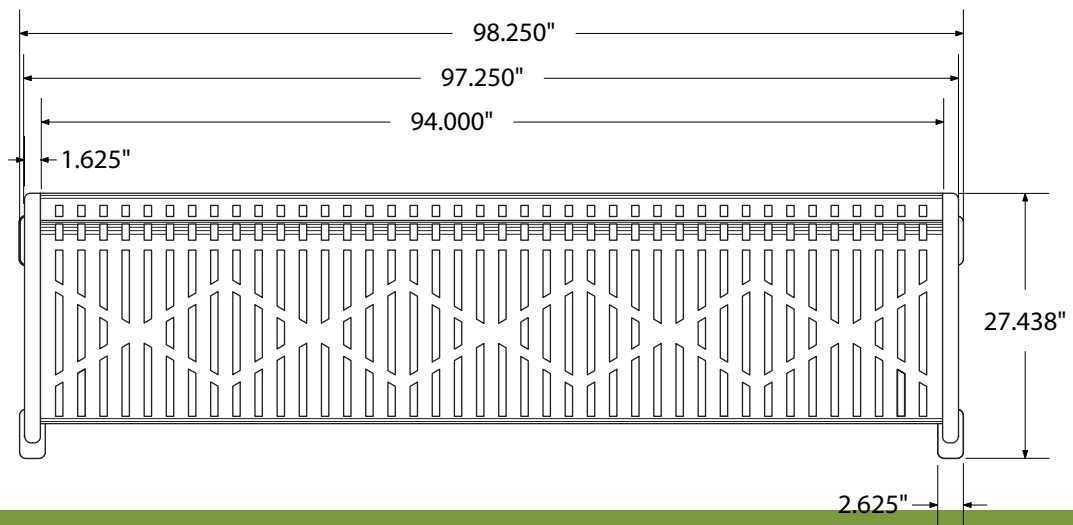

Front view

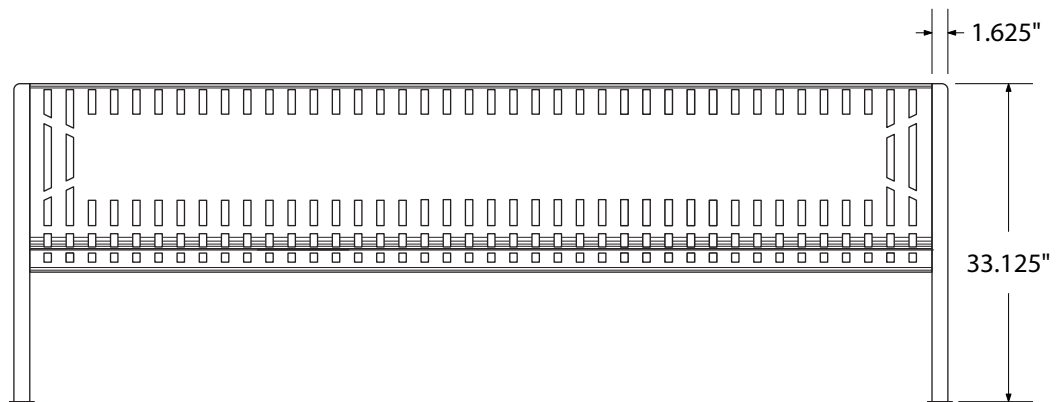

Side view

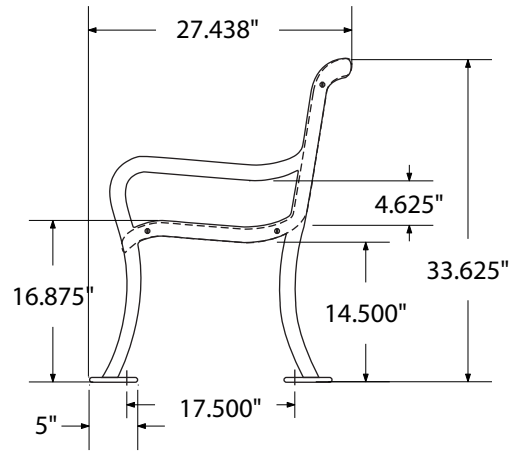

Product finish

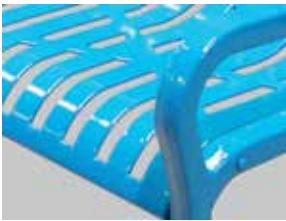

Coated Surfaces

- Thermoplastic coated
- Copolymer-based, environmentally safe
- Does not fade, crack, peel, or warp
- Applied at a thickness 25-30 mils
- 5 year warranty on coating

Construction

- Seat and back - 11 gauge steel
- Cast iron leg structures
- Galvanized hardware

Mounting style

P = Portable: no mount

SM = Surface Mount: concrete anchors through holes in feet

IG = In-Ground: J-rods set in concrete through holes in feet

portable

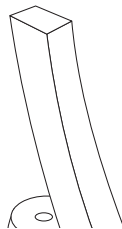

surface mount

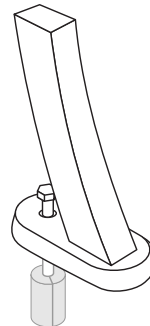

in-ground

