

LENOIR

Lenoir is modular and fluent, with smooth transitions creating sectional-style seating. Designed to coordinate with our Blueridge line of shelving, with matching curves and lengths.



FEATURES

- Wide array of shapes for flexible design options. Straight and curved modular pieces, with or without backs and arms, power options.
- Line includes occasional tables with laminate tops to sit next to or in the middle of a seating section.
- Curves match to the Blueridge line of shelving for ease of coordination.
- Choose from Palmer Hamilton's wide array of upholstery fabrics and laminates for table tops with matching PVC edging.
- Materials selected for longevity and comfort.

SEATING MATERIALS

- The lounge frames are CNC precision cut 7/8" particle board construction, stapled for strength and durability.
- The seats are strapped with Elasmat® Elastic Webbing covered with commercial quality 4" polyurethane foam on the seat

top for comfort, 2" foam on back, and 1" thick foam on the front and sides.

- Fabrics of Grade 2 or higher are recommended. Selections up to Grade 10 available. Options include over 50 standard fabrics and hundreds of designer fabrics to choose from. See our website for selections.

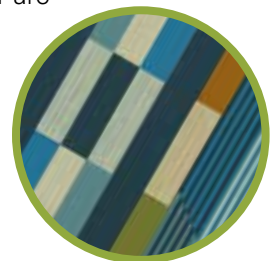

- Contrasting fabrics are available for all upholstered modules. When selecting contrasting upholstery, clearly specify which fabric should be used for the

base, seat and back/arms.

Use the higher grade for pricing purposes.

- Typically we use fabric "Up the Roll" with any stripes/pattern going

from front to back. Please

contact us with any special requests or instructions.

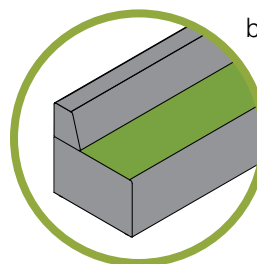

With rounded or straight corners, pair with occasional tables for comfortable group seating.

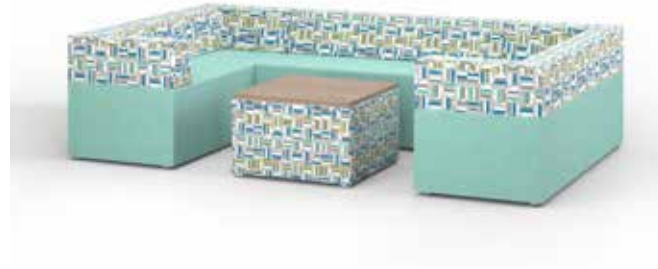

COM FABRIC POLICY

- We accept Customer Own Material (COM) with some restrictions.
- A sample swatch should be sent to Upholstery Department
PALMER HAMILTON
143 S. Jackson Street
Elkhorn, WI 53121-1911
We'll contact you with our approval or questions.
- All yardage requirements for COM are based upon 54" plain non-direction material. Additional yardage may be required based on repeat and matching.
- See the price list for required yardage for each module. Additional yardage will be required for patterned fabrics, per this list:

REPEAT Additional yardage

Based on 54" wide roll

Plain fabric	0%
1-5" repeat	10%
6-10" repeat	15%
11-15" repeat	20%
16-20" repeat	25%
21-30" repeat	30%
31-40" repeat	40%
41"+ repeat	50%

Call us for assistance with any questions.

- Palmer Hamilton takes no responsibility for tailoring, wear-ability or application of COM fabrics and textiles. Any warranty claims will fall to the original vendor of the material.



FEET ON SEATING AND TABLES

- Feet are aluminum 3" bun design, securely attached to furniture frame.

OCCASIONAL TABLE MATERIALS

- The occasional table frames are CNC precision cut 7/8" particle board construction, stapled for strength and durability.
- The base units are upholstered with the same materials as the seating units. We use commercial grade 1/2" foam on the sides.
- The tops are constructed of 1-1/8" thick particle board core with a high pressure laminate top surface, a phenolic backing sheet, and a 3mm PVC edge band.
- Grade 1 laminates are standard, with options for higher grades, upcharges per the price list. See our website for options.



Fit with Blueridge shelving for comfortable media and library centers.

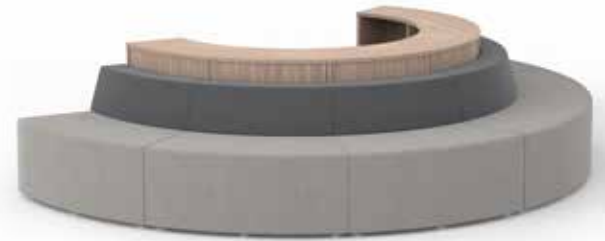

LAMINATES

- **Group 1:** Choose your colors from Wilsonart® laminates. See their website. Palmer Hamilton standards are most colors in Type 335 laminate and finish type ending in -38 or -60. Exceptions apply, including colors that begin with “Y” or end with K-38 or K-60.
- **Group 2:** Standard Pionite®, Nevamar®, and Formica® laminates, and non-standard Wilsonart® laminates Type 335 and 107 Recycled Content, and finish types not ending in -38 or -60.
- **Group 3:** Wilsonart® Specialty Types 136 / 137 Chalkboard Laminates, Arborite®, and premium Pionite®, Nevamar®, and Formica®.
- **Group 4:** Non-Standard Premium Wilsonart® Laminate Types 362 (VDL, Y-Type), 156/336 (Markerboard), 376-HD / 366 Wilsonart® HD, and 515 Compact Laminate.
- **All premium laminates** are subject to an upcharge. Contact Palmer Hamilton with questions.

POWER

- Power is available one side only, left or right, not both sides on one unit.
- The power strip includes (1) Tamper-Resistant (TR) AC outlet (1) USB Type-A charging port: 5V 2.1A (10.5W), and (1) USB Type-C charging port: 5V 2.4A (12W).
- The bevel-edged mounted faceplate is powder-coated black or white with color matched receptacles. Power units have a 10-foot cord.



WARRANTY

See our website.

SHIPPING

Ships fully assembled.

Contrasting fabrics add vibrancy to the lounge area.



Straight Lounge

Dimensions

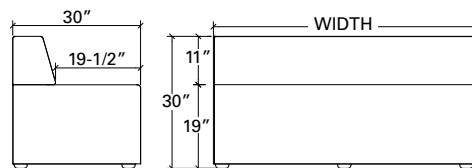

Options

All configurations available in all widths (36", 48", 60", 72"), except half back (HBL and HBR) and two arms (A2) not available on 36"W.

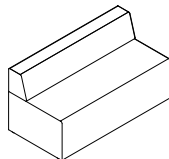

LN-LG-3060S

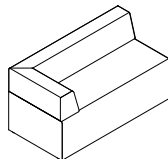

LN-LG-3060S-AL

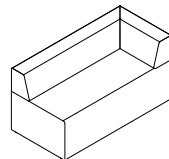

LN-LG-3060S-AR

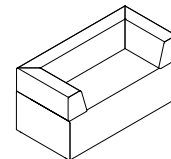

LN-LG-3060S-A2

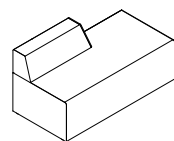

LN-LG-3060S-HBL

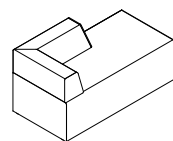

LN-LG-3060S-HBLAL

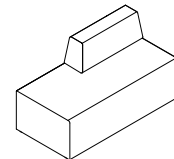

LN-LG-3060S-HBR

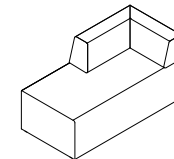

LN-LG-3060S-HBRAR

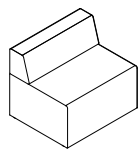

LN-LG-3036S

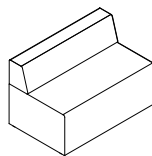

LN-LG-3048S

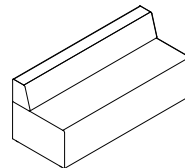

LN-LG-3060S

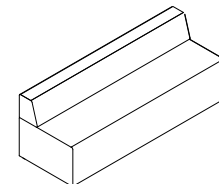

LN-LG-3072S

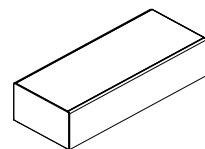

LN-LG-3072S-NB

Fabric Combination Options

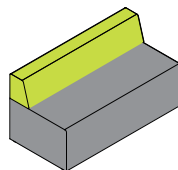

Seat 1 | Back 2

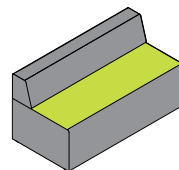

Main 1 | Seat Top 2

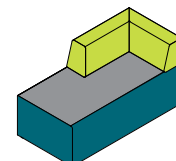

Main 1 | Seat Top 2 | Back/Arms 3

Our curved seating units create interesting arrangements in common spaces.

Curved Lounge

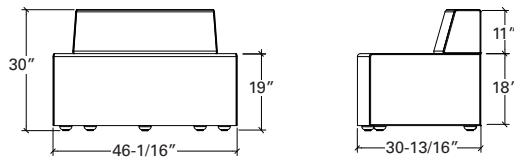
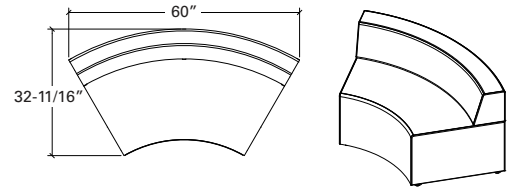
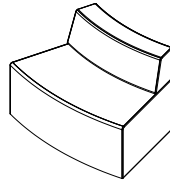

LN-LG-3060OC

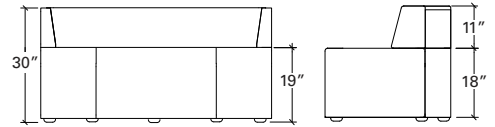

LN-LG-3060IC

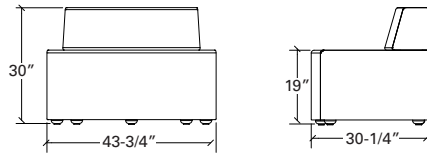
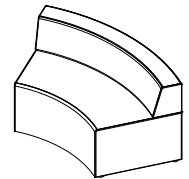
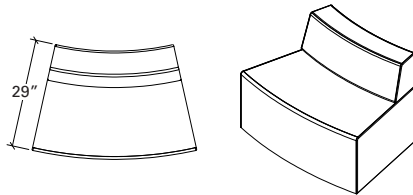

LN-LG-3072OC

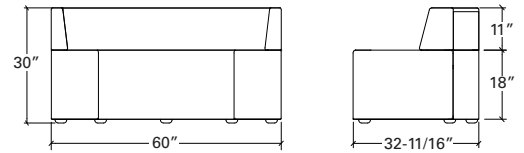

LN-LG-3072IC

Fabric Combination Options

No Back Options

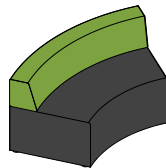

Seat 1 | Back 2

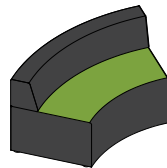

Seat & Back 1 | Seat Top 2

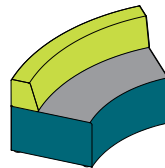

Back 1 | Seat 2 | Seat Top 3

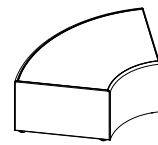

LN-LG-3048IC-NB

Note:

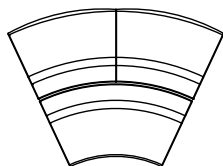

(1) Inner Curve to (2) Outer Curves
60° Inner Curve with 60° Outer Curve
72° Inner Curve with 72° Outer Curve

Occasional tables to add convenience for seating arrangements.



Occasional Tables

Rectangle Occasional Tables

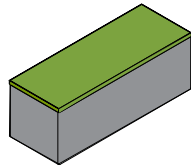

LN-OT-1848R

18" Depth for all
24", 36", 48", 60" Widths
19" Height
Standard with Group 1 laminate; upgrades available.

Round Occasional Tables

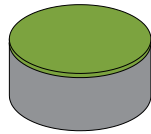

LN-OT-30D

18", 24", 30, 36", 42" Diameters
19" Height
Standard with Group 1 laminate; upgrades available.

Square Occasional Tables

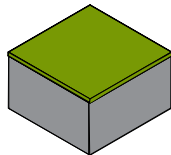

LN-OT-30S

18", 24", 30, 36", 42" Squares
19" Height
Standard with Group 1 laminate; upgrades available.

Imagination is the limit, and repositioning keeps your space fresh.



Example Layouts

Mix Lenoir seats with arms, half back and tables

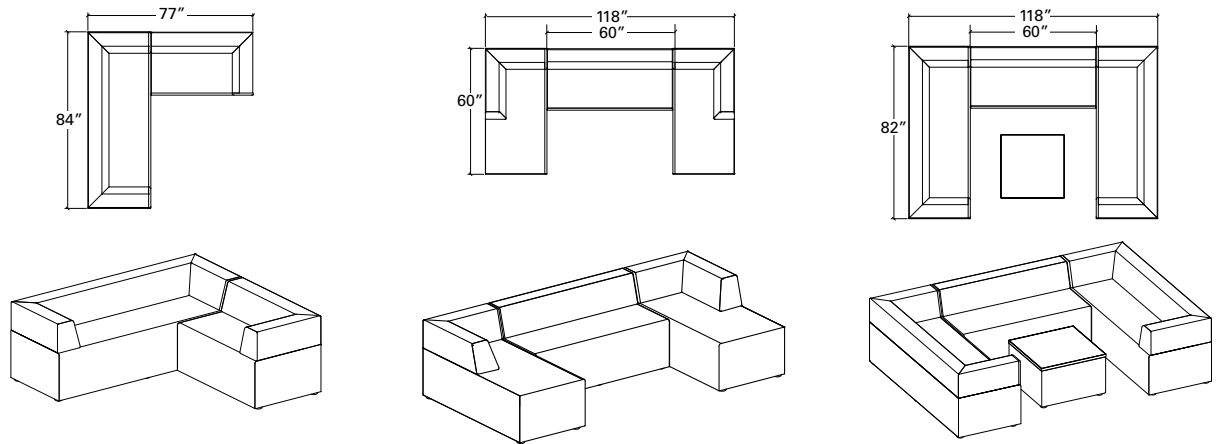

Coordinate with Blueridge shelving

