

TAHOE

Tahoe is a modular system that allows for limitless combinations in lounge seating.



FEATURES

- Wide array of shapes for flexible design options. Straight and curved modular pieces, with or without backs, power options.
- Line includes occasional tables with laminate tops to sit next to or in the middle of a seating section.
- Curved lounge pieces and rounded end units create fluid seating areas without abrupt edges.
- Backless lounge seating in rectangles, squares, curves, and pie shaped seats provide insets to create multiple seating arrangements, and round pieces add extra seats for tables, center spaces or room accents.
- Metal legs or casters make cleaning around and under the furniture simple.
- Choose from Palmer Hamilton's wide array of upholstery fabrics and laminates for table tops with matching PVC edging.
- Materials have been selected for longevity and comfort.

SEATING MATERIALS

- The lounge frames are constructed of puzzle cut 7/8" thick plywood with locking dog bone joint construction that is glued and stapled.
- The seats are strapped with Elasebelt® Elastic Webbing and commercial quality 4" polyurethane foam on the seat top for comfort, 2" foam on back, and 1" thick foam on the front and sides.
- Fabrics of Grade 2 or higher are recommended. Selections up to Grade 10 available. Options include over 50 standard fabrics and hundreds of designer fabrics to choose from. See our website for selections.
- Contrasting fabrics are available for all upholstered modules. When selecting contrasting upholstery, clearly specify which fabric should be used for the base, seat, back, and arms. Use the higher grade for pricing purposes.

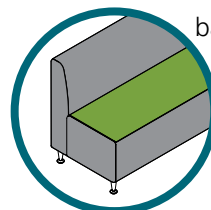
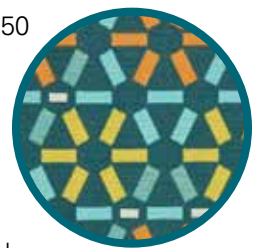

Tables are offered at varying heights to provide seamless solutions with options for top cushions and inset fabric panels to add a cohesive look.

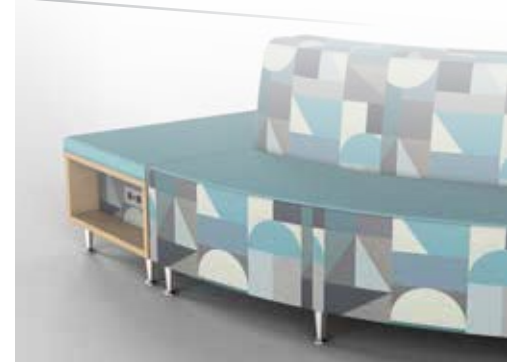

- Typically we use fabric "Up the Roll" with any stripes/pattern going from front to back. Please contact us with any special requests or instructions.

COM FABRIC POLICY

- We accept Customer Own Material (COM) with some restrictions.
- A sample swatch should be sent to Upholstery Department
PALMER HAMILTON
143 S. Jackson Street
Elkhorn, WI 53121-1911
We'll contact you with our approval or questions.
- All yardage requirements for COM are based upon 54" plain non-direction material. Additional yardage may be required based on repeat and matching.
- See the price list for required yardage for each module. Additional yardage will be required for patterned fabrics, per this list:

REPEAT	Additional yardage
Based on 54" wide roll	
Plain fabric	0%
1-5" repeat	10%
6-10" repeat	15%

11-15" repeat	20%
16-20" repeat	25%
21-30" repeat	30%
31-40" repeat	40%
41"+ repeat	50%

Call us for assistance with any questions.

- Palmer Hamilton takes no responsibility for tailoring, wear-ability or application of COM fabrics and textiles. Any warranty claims will fall to the original vendor of the material.

FEET ON SEATING AND TABLES

- Metal legs are 4-3/4" tall, 1-11/16" diameter turned aluminum with securely attached to furniture frame with a sturdy metal threaded rod.
- 3" x 1.25" wide, 4-3/4" high poly swivel lock, non-marking casters are used for all pieces. They are attached to furniture base with a sturdy metal plate secured with screws.



Curves and pie shape end pieces create seating options with inventive layouts.



OCCASIONAL TABLE MATERIALS



- The occasional tables are constructed of 1" particle board core with high pressure laminate on both faces and a 3mm PVC external band on all visible edges.
- Grade 1 laminates are standard, with options for higher grades, upcharges per the price list. See our website for options.
- Tables are constructed with an recessed panel on both sides.
- The top cushions and fabric inset panels are attached to the tables with industrial hook and loop tape.

Laminates

- **Group 1:** Choose your colors from Wilsonart® laminates. See their website. Palmer Hamilton standards are most colors in Type 335 laminate and finish type ending in -38 or -60. Exceptions apply, including colors that begin with "Y" or end with K-38 or K-60.
- **Group 2:** Standard Pionite®, Nevamar®, and Formica® laminates, and non-standard Wilsonart® laminates Type 335 and 107

Recycled Content, and finish types not ending in -38 or -60.

- **Group 3:** Wilsonart® Specialty Types 136 / 137 Chalkboard Laminates, and premium Aborite®, Pionite®, Nevamar®, and Formica®
- **Group 4:** Non-Standard Premium Wilsonart® Laminate Types 362 (VDL, Y-Type), 156/336 (Markerboard), 376-HD / 366 Wilsonart® HD, and 515 Compact Laminate.
- **All premium laminates** are subject to an upcharge. Contact Palmer Hamilton with questions.

POWER

- The standard built-in power unit is a clamp mounted power and charging solution with two AC power outlet and two USB charging ports, constructed with 12A, 120 VAC spill resistant receptacles. Power units have a 108" cord.
- Power units available on one or both sides.



WARRANTY

See our website.

SHIPPING

Ship assembled. Feet are field attached.

Contrasting fabrics add vibrancy to lounge furniture.



Straight Lounge

Dimensions

Single Face, Upholstered Back

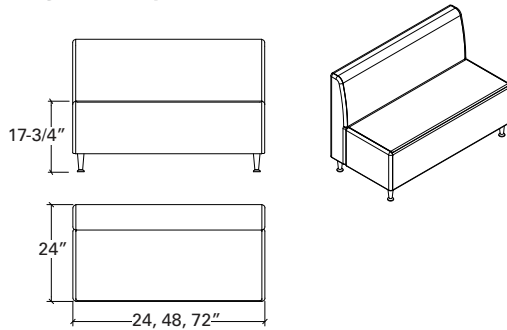

Double Face, Upholstered Back

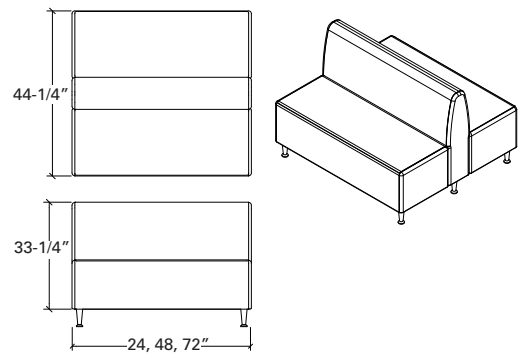

Fabric Combination Options

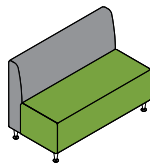

Back 1 | Seat 2

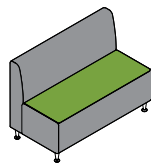

Main 1 | Seat Top 2

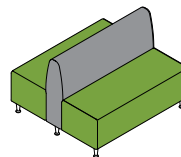

Back 1 | Seat 2

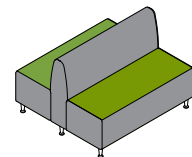

Main 1 | Seat Top 2

Mix straight and curved pieces for dramatic seating arrangements.



Straight Lounge

Dimensions

90° Inner Curve

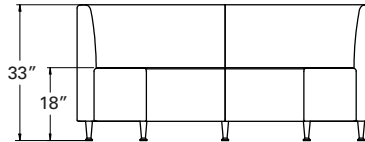
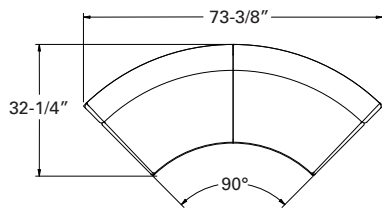

45° Outer Curve

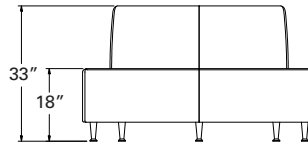
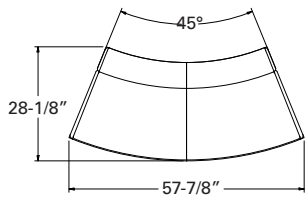

Fabric Combination Options

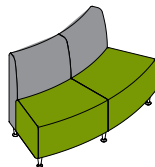

Back 1 | Seat 2

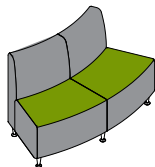

Main 1 | SeatTop 2

Note:

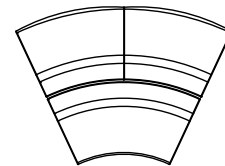

Inner Curve to Outer Curves
90° Inner Curve with 45° Outer Curve

Unusual shapes complete the line to allow for corners, seating pods, and other arrangements.



Dimensions

Pie Shape

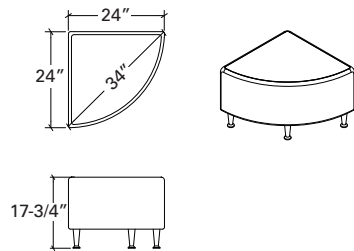

Round Shape

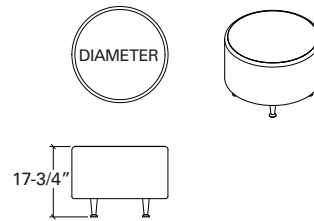

Square/Rectangle Shape

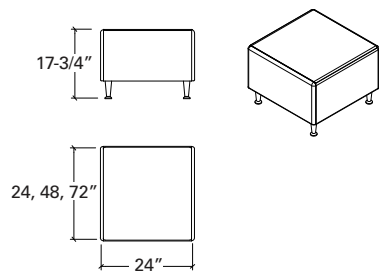

Fabric Combination Options

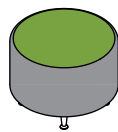

Base 1 | Seat Top 2

An occasional table with power option and space for setting phones while charging adds to the user experience.



Dimensions

